



Funded by the European Union  
بتمويل من الاتحاد الأوروبي



KfW

**School Construction Programme (SCP)  
EUTF Support to Construct Schools in Jordan  
EU No.: TF-MADAD/2018/T04.112  
BMZ No.: 3020 00131  
and  
Funded by the German Government through KfW  
BMZ: 2016 68 334 (SCP I) & 2016 68 938 (SCP II)**

**برنامج بناء المدارس (SCP)  
دعم الاتحاد الأوروبي لإنشاء مدارس في الأردن  
رقم الاتحاد الأوروبي: TF-MADAD/2018/T04.112  
رقم BMZ: 3020 00131  
و  
ممول من قبل الحكومة الألمانية من خلال بنك الإعمار الألماني  
BMZ: 2016 68 334 (SCP I) و 2016 68 938 (SCP II)**

**Request for Quotation (RfQ) Documents  
for**

**Procurement of Sports Equipment for School Construction  
Programme-Phase 1**

**مستندات المناقصة  
لتوريد التجهيزات الرياضية لبرنامج بناء المدارس - المرحلة الأولى**

**Purchaser: Ministry of Education**

**RFQ No. 510929**

**REQUEST FOR QUOTATION FOR  
THE PROCUREMENT OF SPORTS EQUIPMENT**

**تاريخ الإصدار : 14 آذار 2024  
اعداد: إنتلاف مشروع بناء المدارس بقاءة المستشار الرئيسي دورش انترناشونال كونسالتنتس جي ام بي اتش Dorsch  
Consultants GmbH International**

## TABLE OF CONTENTS:

INVITATION FOR BID (دعوة العطاء) .....	3
<b>PART 1 – BIDDING PROCEDURES (إجراءات المناقصة) .....</b>	<b>7</b>
1.1 Definitions(تعريفات) .....	7
1.2 Instruction to Bidders (تعليمات للشركات المتقدمة) .....	7
1.3 Award Criterion and Opening of Bids (إجراءات التقييم و إحالة العطاء) .....	7
1.4 Bidding Forms (نماذج المناقصة).....	10
1.4.1 FORM 1 – Declaration of Undertaking (تعهد التزام) .....	10
1.4.2 FORM 2 – Compliance sheets (Technical Schedules) (الجدول الفنية) .....	15
1.4.3 FORM 3 – Bill of Quantities (BoQ) (جداول الكميات) .....	30
1.4.4 FORM 4 – Warranty Confirmation Form (نموذج التعهد بتقديم الكفالة) .....	43
1.5 Ministry of Education Ministry of Education Letter on Taxation (كتاب وزارة التربية والتعليم بخصوص الضرائب) .....	44
1.6 Eligibility in KfW-Financed Procurement .....	45
<b>PART 2 – SUPPLY REQUIREMENTS (المواصفات المطلوبة) .....</b>	<b>47</b>
2.1 Scope of Work (نطاق الأعمال) .....	47
2.2 Delivery Schedule(جدول التسليم) .....	48
2.3 List of School Locations for Deliveries(قائمة بمواقع المدارس لعمليات التسليم) .....	49
2.4 Technical Specifications (المواصفات الفنية).....	50
<b>PART 3 – CONTRACT (العقد) .....</b>	<b>51</b>
3.1 Contract Terms and Conditions (الشروط والأحكام).....	51
3.2 Form of Contract(نموذج العقد) .....	58
3.3 Performance Security Form(نموذج كفالة حسن التنفيذ) .....	61



## Invitation for Bid (دعوة العطاء)

**Hashemite Kingdom of Jordan**  
**Ministry of Education**  
**Procurement of Sports Equipment for School Construction Programme-**  
**Phase 1**  
**Contract No: 510929**

The Ministry of Education (MoE) has received financing from the German Federal Government through KfW Development Bank (KfW) and from the European Union (EU) through their Regional Trust Fund in Response to the Syrian Crisis (EUTF). The MoE intends to apply parts of this funding to the procurement of Sports Equipment under the Contract for "Procurement of Sports Equipment for School Construction Programme".

Therefore, the Ministry of Education now invites sealed bids from bidders for the supply and delivery of the goods specified in this Bidding Documents.

Interested bidders are invited to bid for the supply and installation (where required), for the Sports Equipment (hereinafter referred to as "Goods") for 4 out of 18 schools (Phase 1). The required Sports Equipment for the 18 schools will be tendered in phases based on the actual completion date of the respective schools.

The first four schools of phase 1 which are the subject of this bid, are funded by the European Union (EU).

Bidders who submit responsive offers for phase 1 will be invited to participate in the following 2 phases by only filling the BoQs. For any new bidders that are invited by the MoE to participate only in phase 2 and 3 they shall complete the full documents.

Interested **eligible**<sup>1</sup> bidders may obtain further information and request clarification from:

Ministry of Education  
International Tender Department, Second Floor, Office 124  
Suleiman Al Nabulsi St 10, Al Abdali, Building 4, PO Box 1646,  
Amman 11118,  
Hashemite Kingdom of Jordan  
Tel: (962) 6 5607181/2703  
Fax: (962) 6 5666019  
Or via

Email: majdylaila2006@yahoo.com

Any questions regarding the RfQ documents shall be sent to the Ministry of Education, at the above address. All questions must be submitted in writing, fax or e-mail. No questions will be responded to if submitted through other means. All questions will be responded via addenda and will be sent to all bidders. All questions must be submitted and received no later than **14 calendar days before the submission deadline**.

A complete set of the "Request for Quotation Documents (RfQ)" is available for interested bidders in English and Arabic, however, note that in case of any conflict or discrepancy the English language version shall prevail. The request for quotation documents are available for review on the Ministry of Education website, for bidders that are interested to bid, the request for quotation documents may be collected from the above address. The documents shall be available for the bidders between **14.03.2024 to 04.04.2024 (Submission Deadline)** during the hours of 09:00 to 13:00 (local time).

<sup>1</sup> Refer to KfW Development Bank Eligibility Criteria in page 33

Bidders shall provide the following documents to collect the RfQ documents:

- 1) **Company Registration**
- 2) **Professional license**

The submitted Bids shall be labelled on the outside with the name of the bidder i.e. supplier and the following:

Tender for	Procurement of Sports Equipment for School Construction Programme-Phase 1 Contract Number: 510929
Delivery Address	Ministry of Education International Tender Department, Second Floor, Office 124 Suleiman Al Nabulsi St 10, Al Abdali, Building 4, PO Box 1646, Amman 11118, Hashemite Kingdom of Jordan Attn: Eng. Majdi Abu Laila
Not to be opened before 14:00 hours <b>04.04.2024</b>	

Bidders shall submit one sealed envelope (1 Original + Hard copy + Soft copy on CD) containing the responsiveness requirements as per Section 1.2, and delivered to the address indicated above on or before 14:00 hours local time, **04.04.2024**

**Electronic bidding will not be permitted, and late submissions will be rejected.**

Evaluation of bids will be according to evaluation method as specified in Section 1.3 of the RfQ document.

The tendering shall be carried out in accordance with the latest version of the KfW Procurement Guidelines, a copy of which is available for download from the KfW website.

<https://www.kfw-entwicklungsbank.de/PDF/Download-Center/PDF-Dokumente-Richtlinien/FZVergaberichtlinien-V-2021-EN.pdf>

KfW retains the right to monitor and review all tender and contract related documents and actions, and KfW's no objection on the conformity of the tender process will be required. However, KfW will not be party to the Contract.

4



دعوة المناقصة  
المملكة الأردنية الهاشمية  
وزارة التربية والتعليم  
توريد التجهيزات الرياضية لبرنامج بناء المدارس - المرحلة الأولى  
رقم العقد: 510929

تلقت وزارة التربية والتعليم الأردنية تمويلًا من الحكومة الألمانية من خلال KfW Entwicklungsbank ومن الاتحاد الأوروبي من خلال صندوق استئماني إقليمي للاستجابة للأزمة السورية وتحتزم تطبيق هذا التمويل لتوريد التجهيزات الرياضية وفقًا للعقد "توريد التجهيزات الرياضية لبرنامج بناء المدارس" والتي يتم إنشاؤها أيضًا من خلال نفس مصدر التمويل وتنفيذها من قبل وزارة الأشغال العامة والإسكان.

و تدعو وزارة التربية والتعليم المناقصين المهتمين لتقديم عروض مختومة لتوريد وتسليم السلع المحددة في هذا العقد.

يُدعى المناقصون المهتمون لتقديم عروض لتوريد وتركيب (حيث يلزم) التجهيزات الرياضية (المشار إليها فيما بعد بـ "السلع") لـ 4 من أصل 18 مدرسة (المرحلة الأولى).

سيتم طرح التجهيزات الرياضية المطلوبة للمدارس الثمانية عشر على مراحل بناءً على تاريخ الانتهاء الفعلي للمدارس المعنية.

المدارس الأربع الأولى من المرحلة الأولى التي هي موضوع هذا العطاء، يتم تمويلها من قبل الاتحاد الأوروبي. سيتم طرح عطاءات توريد لتجهيزات الرياضية المطلوبة للمدارس المتبقية بمرحلة استنادًا إلى تاريخ الاكتمال الفعلي.

ستتم دعوة المناقصون الذين يقدمون عروضًا متاهلة للمرحلة الأولى للمشاركة في المرحلتين التاليتين من خلال ملء جداول الكميات فقط. بالنسبة لأي مناقصون جدد تتم دعوتهم من قبل وزارة التربية والتعليم للمشاركة فقط في المرحلتين الثانية والثالثة، يجب عليهم إكمال المستندات الكاملة.

يمكن للمتقدمين المؤهلين والمهتمين الحصول على معلومات إضافية وطلب توضيح من:

وزارة التربية والتعليم  
قسم العطاءات الدولية، الطابق الثاني، مكتب 124

العبدلي ص.ب. 1646

عمان 11118الأردن

الهاتف: 6 5607181/2703 (962)

الفاكس: 6 5666019 (962)

أو عبر

البريد الإلكتروني majdylaila2006@yahoo.com

توجه أية أسئلة بخصوص وثائق المناقصة إلى وزارة التربية والتعليم، على العنوان أعلاه. يجب تقديم جميع الأسئلة بالكتابة، سواء عبر الفاكس أو البريد الإلكتروني. ولن يتم الرد على أي أسئلة إذا تم تقديمها من خلال وسائل أخرى. سيتم الرد على جميع الأسئلة عبر ملحق وسيتم إرسالها إلى جميع المتقدمين. يجب تقديم جميع الأسئلة قبل 14 يومًا من آخر موعد للتسليم.

مجموعة كاملة من "طلب عرض الأسعار RFQ" ستكون متاحة للمتقدمين المهتمين باللغتين الإنجليزية والعربية، ومع ذلك يجب ملاحظة أنه في حالة حدوث أي تعارض أو تضارب، ستسود النسخة باللغة الإنجليزية. يمكن استلام وثائق طلب عرض الأسعار من العنوان المذكور أعلاه. ستكون الوثائق متاحة للمتقدمين بين 14 آذار 2024 و 04 نيسان 2024 خلال ساعات 09:00 إلى 13:00 (بالتوقيت المحلي).

يجب على المتقدمين تقديم الوثائق التالية لإستلام وثائق طلب عرض الأسعار:

(1) السجل التجاري للشركة

(2) رخصة المهنة

على المناقص، المورد وضع اسمه الرسمي على مغلف المناقصة من الخارج بالإضافة إلى ما يلي:

عطاء لتوريد التجهيزات الرياضية لبرنامج بناء المدارس رقم العطاء: RFQ No. 510929	تقديم عرض مالي وفني
وزارة التربية والتعليم قسم العطانات الدولية، الطابق الثاني ، مكتب 124 العبدلي ص.ب. 1646 عمان 11118 المهندس: مجدي ابو ليلى	عنوان التسليم
يمنع فتح المغلف قبل الساعة 2:00 من تاريخ 04 نيسان 2024	

يجب على المتقدمين تقديم متطلبات التأهيل داخل ظرف واحد مختوم كما هو محدد في القسم 1.2 ، ويجب تسليمه إلى العنوان المشار إليه أعلاه قبل الساعة 14:00 بالتوقيت المحلي من تاريخ 04 نيسان 2024.

لن يُسمح بالمناقصة الإلكترونية، وسيتم رفض التقديمات المتأخرة.

سيتم تقييم العروض وفقاً لطريقة التقييم كما هو محدد في القسم 1.3 من وثيقة طلب عرض الاسعار.

ستتم المناقصة وفقاً لأحدث إصدار للمبادئ التوجيهية للمشتريات من KfW، وهو متاح للتنزيل من موقع KfW.

<https://www.kfw-entwicklungsbank.de/PDF/Download-Center/PDF-Dokumente-Richtlinien/FZVergaberichtlinien-V-2021-EN.pdf>

تحتفظ KfW ببعض حقوق الموافقة، بما في ذلك عدم الممانعة على الموردين المُختارين. ومع ذلك، لن تكون KfW طرفاً في العقد.

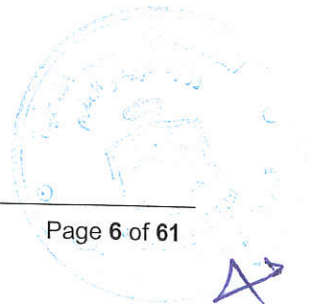

## PART 1 – Bidding Procedures (إجراءات المناقصة)

### 1.1 Definitions (تعريفات)

- «KfW» هي وكالة التمويل التي يتم من خلالها تمويل التعاون المالي الألماني. وتقع على عاتقها مسؤولية تنفيذ البرنامج، بما في ذلك المدارس الممولة من الاتحاد الأوروبي.
  - «EU» يعني الاتحاد الأوروبي.
  - «MoE» تعني وزارة التعليم وفي هذه الوثائق باسم المشتري.
  - كلمة "المناقص" تعني الشركة أو مجموعة الشركات المتقدمة للعطاء. الشركة المتقدمة (المناقص) التي يتم إحالة العطاء لها تسمى: "المورد".
  - كلمة "المورد" تعني الشركة أو الشركات التي تمت إحالة العطاء إليها.
  - يعني مصطلح «المشتري»: «وزارة التعليم» المصطلحين مترادفين ويستخدمان بالتبادل في جميع أجزاء الوثيقة.
- Bidder: The company of group of companies or the representative thereof submitting the bid. That bidder which is awarded the Contract becomes the Supplier.
  - Supplier: The company of group of companies or the representative thereof awarded the Contract by the Purchaser to supply the Goods.
  - Purchaser: Ministry of Education

### 1.2 Instruction to Bidders (تعليمات للشركات المتقدمة)

1. The "Purchaser" is the Ministry of Education of the Hashemite Kingdom of Jordan.
2. The EU sections of this Contract are financed by the European Union through KfW from their Regional Trust Fund in Response to the Syrian Crisis (EUTF).
3. The "Consultant" for the purposes of this Purchase Order means the Joint Venture Dorsch International Consultants GmbH as the Leading Partner, with AHT GROUP AG and DAR AL OMRAN Planning, Architecture and Engineering.

#### Qualification and Responsiveness Requirements:

- Company Registration (At the time of collecting documents)
- Professional license (At the time of collecting documents)
- Completely filled-out FORM 1 – Declaration of Undertaking
- Completed FORM 2 – Compliance sheets (Technical Schedules)
- Completely filled-out, stamped FORM 3– BoQs (and total price on the last page of the form signed)
- Completed FORM 4 – Confirmation to providing standard Manufacturing Warranty as per the technical specifications.

The purchaser shall reject bids that are not substantially responsive to the qualification requirements of this RfQ document.

### 1.3 Award Criterion and Opening of Bids (إجراءات التقييم و إحالة العطاء)

The process of evaluation of the Bid and subsequent award shall be as follows:

1. The Bidder shall complete all items in the Bills of Quantities. Partial bids will not be accepted and will lead to rejection.
2. All timely bids received will be publicly opened at the date and time advised by the Purchaser and stipulated under the "Invitation to Bid"
3. The Contract will be awarded to the lowest compliant total priced Bid excluding sales tax and custom duties, and the amount of Contract award will be total price excluding sales tax



and custom duties. Sales tax and custom duties if any shall be reimbursed by the ministry of education as per the letter of taxation in section 1.5.

4. Envelopes containing the bids will be opened by a committee in a public opening session on the date specified in the Invitation to Bid at 15:00 hours local time.
5. The price offer in the bid shall be **valid for 120 days** from the submission date.
6. The bid shall be in accordance with the stamped BoQ from MoE provided in this document and it shall be signed and stamped by the Bidder.
7. If there is a discrepancy between the unit price and the line item total that is obtained by multiplying the unit price by the quantity, the unit price shall prevail and the line item total shall be corrected, unless in the opinion of the Purchaser there is an obvious misplacement of the decimal point in the unit price, in which case the line item total as quoted shall govern and the unit price shall be corrected;
8. If there is an error in a total corresponding to the addition or subtraction of subtotals, the subtotals shall prevail and the total shall be corrected.
9. If there is a discrepancy between words and figures, the amount in words shall prevail, unless the amount expressed in words is related to an arithmetic error.



## معايير إحالة العطاء و فتح العروض

سيكون تقييم العروض و لاحقاً الإحالة على النحو التالي:

1. يجب على المورد استكمال كافة البنود الواردة في جدول الكميات ، ولن يتم قبول العروض التي تحتوي على جزء من البنود وبناء على ذلك سيتم رفض العرض المقدم من المناقص.
2. سيتم فتح جميع العروض التي تم استلامها في الوقت المناسب بشكل علني في التاريخ والوقت الذي يتم تحديده من قبل المشتري والمبين في "دعوة المناقصة".
3. سيتم إحالة العطاء على المناقص صاحب الأقل سعراً والمطابق فنياً لمتطلبات اوراق المناقصة والعطاء. إذا تبين أن المناقص صاحب الأقل سعراً لم يكن مطابقاً تماماً لشروط ومتطلبات العطاء، سيتم رفض عرضه وسيتم تقييم العرض الثاني الأقل سعراً من الناحية الفنية. ستستمر هذا العملية حتى يتم تحديد العرض الأقل سعراً والمطابق تماماً للشروط الفنية.
4. سيتم فتح مغلقات العروض من قبل لجنة في جلسة فتح العروض بالتاريخ المحدد في دعوة العطاء في تمام الساعة الثالثة عصراً (15:00) حسب التوقيت المحلي.
5. يجب أن يكون عرض السعر صالحاً للقبول لمدة 120 يوماً من اخر موعد لتسليم العروض.
6. يجب أن يكون العرض المالي متوافقاً مع جدول الكميات المختوم من وزارة التربية والتعليم في هذه الوثيقة ويجب أن يتم التوقيع عليها وختمها من قبل المناقص.
7. في حال وجود تضارب بين سعر الوحدة والمبلغ الاجمالي (يتم تحصيله عن طريق ضرب سعر الوحدة بعددها) فسيتم اعتماد سعر الوحدة وتصحيح المبلغ الاجمالي وفقاً لذلك، ما لم يكن هناك في رأي المشتري ما يثبت بشكل واضح أن العلامة العشرية في غير موضعها في سعر الوحدة، وفي هذه الحالة سيسود المبلغ الإجمالي ويتم تصحيح سعر الوحدة .
8. في حال وجود خطأ في مجموع المبالغ في جدول الكميات نتيجة عمليات الإضافة أو الطرح للمجاميع الفرعية فيجب اعتماد المجاميع الفرعية وتصحيح السعر الإجمالي وفقاً لذلك .
9. في حال وجود تضارب بين السعر بالإرقام و السعر بالكلمات، يجب اعتماد السعر بالكلمات ما لم يكن المبلغ المعبر عنه بالكلمات مرتبط بخطأ حسابي.

## 1.4 Bidding Forms ( نماذج المناقصة )

### 1.4.1 FORM 1 – Declaration of Undertaking (تعهد التزام)

RfQ No. 510929 Procurement of Sports Equipment for School Construction Programme-  
Phase 1: ("Contract")<sup>2</sup>

To: ("Project Executing Agency")

1. We recognise and accept that KfW only finances projects of the Project Executing Agency ("PEA")<sup>3</sup> subject to its own conditions which are set out in the Funding Agreement it has entered into with the PEA. As a matter of consequence, no legal relationship exists between KfW and our company, our Joint Venture or our Subcontractors under the Contract. The PEA retains exclusive responsibility for the preparation and implementation of the Tender Process and the performance of the Contract.
2. We hereby certify that neither we nor any of our board members or legal representatives nor any other member of our Joint Venture including Subcontractors under the Contract are in any of the following situations:
  - 2.1) being bankrupt, wound up or ceasing our activities, having our activities administered by courts, having entered into receivership, reorganisation or being in any analogous situation;
  - 2.2) convicted by a final judgement or a final administrative decision or subject to financial sanctions by the United Nations, the European Union or Germany for involvement in a criminal organisation, money laundering, terrorist-related offences, child labour or trafficking in human beings; this criterion of exclusion is also applicable to legal Persons, whose majority of shares are held or factually controlled by natural or legal Persons which themselves are subject to such convictions or sanctions;
  - 2.3) having been convicted by a final court decision or a final administrative decision by a court, the European Union, national authorities in the Partner Country or in Germany for Sanctionable Practice in connection with a Tender Process or the performance of a Contract or for an irregularity affecting the EU's financial interests (*in the event of such a conviction, the Applicant or Bidder shall attach to this Declaration of Undertaking supporting information showing that this conviction is not relevant in the context of this Contract and that adequate compliance measures have been taken in reaction*);
  - 2.4) having been subject, within the past five years to a contract termination fully settled against us for significant or persistent failure to comply with our contractual obligations during such Contract performance, unless this termination was challenged and dispute resolution is still pending or has not confirmed a full settlement against us;

<sup>2</sup> Capitalised terms used, but not otherwise defined in this Declaration of Undertaking have the meaning given to such term in KfW's "Guidelines for the Procurement of Consulting Services, Works, Goods, Plant and Non-Consulting Services in Financial Cooperation with Partner Countries".

<sup>3</sup> The PEA means the purchaser, the employer, the client, as the case may be, for the procurement of Consulting Services, Works, Plant, Goods or Non-Consulting Services.



- 2.5) not having fulfilled applicable fiscal obligations with regard to the payment of taxes at the respective tax residence and in the country of origin of the PEA (*contractors based in Annex 1 countries (https://www.consilium.europa.eu/de/policies/eu-list-of-non-cooperative-jurisdictions/) must submit a fully completed and legally countersigned declaration of tax conformity (Appendix1 to the Declaration of Undertaking) in addition to the Declaration of Undertaking at the time of award of the contract/contract review. This shall become an integral part of the contract. Failure to submit may result in exclusion from the awarding procedure. For contractors based in countries not listed as Annex I countries, only the Declaration of Undertaking must be submitted, and not the declaration of tax conformity*);
- 2.6) being subject to an exclusion decision of the World Bank or any other multilateral development bank and being listed on the website <http://www.worldbank.org/debarr> or respectively on the relevant list of any other multilateral development bank (*in the event of such exclusion, the Applicant or Bidder shall attach to this Declaration of Undertaking supporting information showing that this exclusion is not relevant in the context of this Contract and that adequate compliance measures have been taken in reaction*); or
- 2.7) being guilty of misrepresentation in supplying the information required as condition to participation in this Tender Procedure.
3. We hereby certify that neither we, nor any of the members of our Joint Venture or any of our Subcontractors under the Contract are in any of the following situations of conflict of interest:
- 3.1) being an affiliate controlled by the PEA or a shareholder controlling the PEA, unless the stemming conflict of interest has been brought to the attention of KfW and resolved to its satisfaction;
- 3.2) having a business or family relationship with a PEA's staff involved in the Tender Process or the supervision of the resulting Contract, unless the stemming conflict of interest has been brought to the attention of KfW and resolved to its satisfaction;
- 3.3) being controlled by or controlling another Applicant or Bidder, or being under common control with another Applicant or Bidder, or receiving from or granting subsidies directly or indirectly to another Applicant or Bidder, having the same legal representative as another Applicant or Bidder, maintaining direct or indirect contacts with another Applicant or Bidder which allows us to have or give access to information contained in the respective Applications or Offers, influencing them or influencing decisions of the PEA;
- 3.4) being engaged in a Consulting Services activity, which, by its nature, may be in conflict with the assignments that we would carry out for the PEA;
- 3.5) in the case of procurement of Works, Plant or Goods:
- having prepared or having been associated with a Person who prepared specifications, drawings, calculations and other documentation to be used in the Tender Process of this Contract;
  - having been recruited (or being proposed to be recruited) ourselves or any of our affiliates, to carry out works supervision or inspection for this Contract;
4. If we are a state-owned entity, and compete in a Tender Process, we certify that we have legal and financial autonomy and that we operate under commercial laws and regulations.



5. We undertake to bring to the attention of the PEA, which will inform KfW, any change in situation with regard to points 2 to 4 here above.
6. In the context of the Tender Process and performance of the corresponding Contract:
  - 6.1) neither we nor any of the members of our Joint Venture nor any of our Subcontractors under the Contract have engaged or will engage in any Sanctionable Practice during the Tender Process and in the case of being awarded a Contract will engage in any Sanctionable Practice during the performance of the Contract;
  - 6.2) neither we nor any of the members of our Joint Venture or any of our Subcontractors under the Contract shall acquire or supply any equipment nor operate in any sectors under an embargo of the United Nations, the European Union or Germany; and
  - 6.3) we commit ourselves to complying with and ensuring that our Subcontractors and major suppliers under the Contract comply with international environmental and labour standards, consistent with laws and regulations applicable in the country of implementation of the Contract and the fundamental conventions of the International Labour Organisation<sup>4</sup> (ILO) and international environmental treaties. Moreover, we shall implement environmental and social risks mitigation measures when specified in the relevant environmental and social management plans or other similar documents provided by the PEA and, in any case, implement measures to prevent sexual exploitation and abuse and gender based violence.
7. In the case of being awarded a Contract, we, as well as all members of our Joint Venture partners and Subcontractors under the Contract will, (i) upon request, provide information relating to the Tender Process and the performance of the Contract and (ii) permit the PEA and KfW or an auditor appointed by either of them, and in the case of financing by the European Union also to European institutions having competence under European Union law, to inspect the respective accounts, records and documents, to permit on the spot checks and to ensure access to sites and the respective project.
8. In the case of being awarded a Contract, we, as well as all our Joint Venture partners and Subcontractors under the Contract undertake to preserve above mentioned records and documents in accordance with applicable law, but in any case for at least six years from the date of fulfillment or termination of the Contract. Our financial transactions and financial statements shall be subject to auditing procedures in accordance with applicable law. Furthermore, we accept that our data (including personal data) generated in connection with the preparation and implementation of the Tender Process and the performance of the Contract are stored and processed according to the applicable law by the PEA and KfW.

Name: \_\_\_\_\_ In the capacity of: \_\_\_\_\_

Duly empowered to sign in the name and on behalf of<sup>5</sup>: \_\_\_\_\_

Signature:

Dated:

<sup>4</sup> In case ILO conventions have not been fully ratified or implemented in the Employer's country the Applicant/Bidder/Contractor shall, to the satisfaction of the Employer and KfW, propose and implement appropriate measures in the spirit of the said ILO conventions with respect to a) workers grievances on working conditions and terms of employment, b) child labour, c) forced labour, d) worker's organisations and e) non-discrimination.

<sup>5</sup> In the case of a JV, insert the name of the JV. The person who will sign the application, bid or proposal on behalf of the Applicant/Bidder shall attach a power of attorney from the Applicant/Bidder.



## **Appendix1 to the Declaration of Undertaking**

Declaration of tax conformity – binding confirmation for legal persons

### **Name of company**

I hereby confirm with my signature that:

1. I am authorised to make this declaration on behalf of the above company;
2. the company properly pays all taxes in accordance with the tax laws of the country in which the company is domiciled;
3. the company is not currently nor has been in the past involved in any legal proceedings concerning the taxation of the company;
4. the company will duly pay taxes that may arise from the provision of contracted services;
5. all information and statements provided in advance are complete, accurate in terms of content and currently correct.

.....

(Place)

.....

(Date)

.....

(Signature(s))

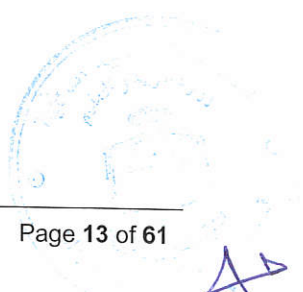



**Appendix1 to the Declaration of Undertaking**

**Declaration of tax conformity – binding confirmation for natural persons**

I hereby confirm with my signature that:

1. I make this declaration in my name/on my own account;
2. I duly pay taxes that I am obliged to pay under the tax law of my country of residence;
3. I am not currently involved in tax law court proceedings, nor have I been in the past;
4. I will duly pay taxes that may arise from the provision of contracted services;
5. I have filled in all the information and statements of this confirmation in full, accurately in terms of content and that they are up to date at this time.

.....

(Place)

(Date)

(Name of the person)

.....

(Signature)

### 1.4.2 FORM 2 – Compliance sheets (Technical Schedules) (الجدول الفنية)

Bidder shall fill in the compliance sheet (Technical Schedules) with “comply” or “not comply” for every line of FORM-2 the technical schedules. For non-compliant items, bidders shall describe the non-compliance; the evaluation committee may accept or reject this and may ask for a substitution.

The Bidder shall fill in the following technical schedules with the specification of the offered items for each of the following 4 schools::

EU Component: Schools EU1 Al Nahda School, EU2 Howwara School, EU17 Hakama School, EU18 Hay Al Dobbat School.

1. Football or Soccer Ball			
Nr.	Technical Requirement		Comply/Non-compliant (Description of any non-compliance)
<b>Component &amp; Specification</b>			
1	Shape & Material of Manufacture	Spherical in shape and its outer shell is made of natural or artificial leather and Does not include any material that may present a danger to the players.	
2	Dimensions	Ball circumference (68 - 70) cm Ball weight (410 - 450) g	
3	Notes	According to the international legal dimensions	

2. Volleyball			
Nr.	Technical Requirement		Comply/Non-compliant (Description of any non-compliance)
<b>Component &amp; Specification</b>			
1	Shape & Material of Manufacture	Complete pelletizing and made of natural or artificial leather.	
2	Colour	Coloured	
3	Dimensions	Ball circumference (65 - 67) cm Ball weight (260 - 280) g Internal Ball pressure (0.3 - 0.325) kg/cm <sup>2</sup>	
4	Notes	According to the international legal dimensions	

3. Volleyball Stands			
Nr.	Technical Requirement		Comply/Non-compliant (Description of any non-compliance)
Component & Specification			
1	Shape & Material of Manufacture	Made of circular and galvanized iron	
2	Dimensions	With a diameter of (10) cm approx. and height (255) cm approx. With the possibility of adjusting the height by gradient handles	
3	Installation	Place the post in a hole not less than (45) cm approx. so that an appropriate base of iron is placed inside the hole to place and install the menus perpendicularly with the availability of a suitable cover placed after lifting the menus and removed on the piece (base) Installed in the ground.	
4	Attachments	Linen or Nylon mesh with legal dimensions and dimensions with fixing wire and handle.	
5	Notes	According to the international legal dimensions	

4. Volleyball Net			
Nr.	Technical Requirement		Comply/Non-compliant (Description of any non-compliance)
Component & Specification			
1	Shape & Material of Manufacture	A volleyball Net made of nylon or cotton threads. The Mesh Eyes are square.	
2	Dimensions	The Net of the Volleyball Court is (1) m Width with (9.50 - 10) m Length Constructed of (10) cm approx. square black mesh.	
3	Attachments	Upper and lower extremities: A double layer of linen top passes through a cable for fixation approximately (7) cm wide for the layer, from the bottom passes by a thread of fixation and a double layer of linen approximately (5) cm wide.	
4	Notes	According to the international legal dimensions	



5. Basketball for Male			
Nr.	Technical Requirement		Comply/Non-compliant (Description of any non-compliance)
Component & Specification			
1	Shape & Material of Manufacture	Full balling shape The surface is made of natural or artificial leather.	
2	Dimensions	Circumference (749 - 780) mm Weight (576 - 650) g	
3	Attachments	Beige or orange	
4	Notes	According to the international legal dimensions Size (7)	

6. Basketball for Female			
Nr.	Technical Requirement		Comply/Non-compliant (Description of any non-compliance)
Component & Specification			
1	Shape & Material of Manufacture	Full balling shape The surface is made of natural or artificial leather.	
2	Dimensions	Circumference (723.9) mm approx. Weight (566.99) g approx.	
3	Colour	Beige or orange	
4	Notes	According to the international legal dimensions Size (6)	

7. Handball for Male			
Nr.	Technical Requirement		Comply/Non-compliant (Description of any non-compliance)
Component & Specification			
1	Shape & Material of Manufacture	Made of natural or artificial leather. Its outer surface should not be glossy or smooth	
2	Dimensions	Its Circumference ranges from (58) to (60) cm And its weight is from (425 – 475) g.	
3	Colour	Coloured Matte color (not shiny) Not smooth	

7. Handball for Male			
Nr.	Technical Requirement		Comply/Non-compliant (Description of any non-compliance)
4	Notes	According to the international legal dimensions Size (1)	

8. Handball for Female			
Nr.	Technical Requirement		Comply/Non-compliant (Description of any non-compliance)
Component & Specification			
1	Shape & Material of Manufacture	Made of natural or artificial leather. Its outer surface should not be glossy or smooth	
2	Dimensions	the circumference of the ball (54 - 56) cm And its weight is from (325 - 375) g.	
3	Colour	Coloured Matte color (not shiny) Not smooth	
4	Notes	According to the international legal dimensions Size (2)	

9. Pair of Handball Nets			
Nr.	Technical Requirement		Comply/Non-compliant (Description of any non-compliance)
Component & Specification			
1	Description	Rectangular consisted of: The mesh & iron bars	
2	Material of Manufacture	The mesh made of thick nylon, linen, or hemp fibres.	
3	Dimensions	The mesh opening is square And measures (10 × 10) cm approx.	
4	Attachments	Surrounded by bars made of iron (2 - 3) m. in width, and (1.8 - 2) m. in height. The goal fixed to the court or to the wall from behind.	
5	Colour	Two colours (red and white or black and white)	
6	Notes	According to the international legal dimensions	



10. Tablet or discus for Male (1.5) kg (Discus)			
Nr.	Technical Requirement		Comply/Non-compliant (Description of any non-compliance)
<b>Component &amp; Specification</b>			
1	Material of Manufacture	Made of even wood and rounded by a metal frame or rubber.	
2	Notes	According to the international legal dimensions	

11. Tablet or discus for Female (1) kg (Discus)			
Nr.	Technical Requirement		Comply/Non-compliant (Description of any non-compliance)
<b>Component &amp; Specification</b>			
1	Material of Manufacture	Made of even wood and rounded by a metal frame or rubber.	
2	Notes	According to the international legal dimensions	

12. Metal ball for male			
Nr.	Technical Requirement		Comply/Non-compliant (Description of any non-compliance)
<b>Component &amp; Specification</b>			
1	Material of Manufacture	Metal steel ball	
2	The Weight	(5) kg approx.	
3	Notes	According to the international legal dimensions	

13. Metal ball for female			
Nr.	Technical Requirement		Comply/Non-compliant (Description of any non-compliance)
<b>Component &amp; Specification</b>			
1	Material of Manufacture	Metal steel ball	
2	The Weight	(4) kg approx.	
3	Notes	According to the international legal dimensions	



14. Javelin for Male			
Nr.	Technical Requirement		Comply/Non-compliant (Description of any non-compliance)
<b>Component &amp; Specification</b>			
1	Material of Manufacture	Made of Aluminium	
2	The Weight	(700) g approx.	
3	Notes	According to the international legal dimensions	

15. Javelin for Female			
Nr.	Technical Requirement		Comply/Non-compliant (Description of any non-compliance)
<b>Component &amp; Specification</b>			
1	Material of Manufacture	Made of Aluminium	
2	The Weight	(600) g approx.	
3	Notes	According to the international legal dimensions	

16. Pair of Table Tennis Rackets			
Nr.	Technical Requirement		Comply/Non-compliant (Description of any non-compliance)
<b>Component &amp; Specification</b>			
1	Material of Manufacture	Made of wood covered with rubber on both sides and between each layer of rubber and wood layer, sponge thickness of (1.5) mm approx.	
2	Notes	According to the international legal dimensions	

17. Table Tennis			
Nr.	Technical Requirement		Comply/Non-compliant (Description of any non-compliance)
<b>Component &amp; Specification</b>			
1	Material of Manufacture	Made of suitable wood, the surface is smooth	
2	Color	Painted in blue or green colour	

17. Table Tennis			
Nr.	Technical Requirement		Comply/Non-compliant (Description of any non-compliance)
3	Attachments & Installation	It is equipped with wheels and foldable and equipped with a metal frame from the bottom of the wood to prevent arching, and equipped with a legal net and net holder, and the table rests on hollow metal legs.	
4	Notes	According to the international legal dimensions	

18. Dozens of Table Tennis Balls			
Nr.	Technical Requirement		Comply/Non-compliant (Description of any non-compliance)
Component & Specification			
1	Dozen	Dozens of (6) Balls	
2	Material of Manufacture	Made of polypropylene	
3	Shape & Dimensions	Spherical With a diameter of (40) mm approx. So that the line between the two halves is not clear.	
4	Notes	According to the international legal dimensions	

19. Pair of Badminton Rackets			
Nr.	Technical Requirement		Comply/Non-compliant (Description of any non-compliance)
Component & Specification			
1	Material of Manufacture	Made of suitable material (wood is not acceptable) Strong nylon racquet yarn.	
2	Description	The head of the racket and the blade are connected without dividers	
3	Notes	According to the international legal dimensions	



20. Pair of Badminton Stands		
Nr.	Technical Requirement	Comply/Non-compliant (Description of any non-compliance)
<b>Component &amp; Specification</b>		
1	Material of Manufacture & Measurements	Made of hollow metal measuring (4 × 4) cm approx. The height of the upright above the ground (155) cm approx.
2	Installation	The hollow metal installed on a heavy metal base equipped with wheels and prevent it from falling and vibration, In addition, maintain the strength of the tensile network.
3	Notes	According to the international legal dimensions

21. Badminton Net		
Nr.	Technical Requirement	Comply/Non-compliant (Description of any non-compliance)
<b>Component &amp; Specification</b>		
1	Dimensions	(6.1) m × (0.76) m approx. One eye in a square-shaped grid (2) cm × (2) cm approx.
2	Upper and lower limbs	Double layer of top of linen with a width of (3) cm approx. From the bottom passes through a thread for fastening without a double layer.
3	Notes	According to the international legal dimensions

22. Dozens of Shuttlecocks		
Nr.	Technical Requirement	Comply/Non-compliant (Description of any non-compliance)
<b>Component &amp; Specification</b>		
1	Dozen	Dozens of (12) flying feathers.
2	Shape	Almost conical funnel
3	Material of Manufacture	Plastic from (14 – 16) feather cone tips and the circular head of cork covered with a thin layer of rubber.
4	Notes	According to the international legal dimensions



23. Tape Measure (50) meter			
Nr.	Technical Requirement		Comply/Non-compliant (Description of any non-compliance)
<b>Component &amp; Specification</b>			
1	Display	(1.7) cm approx.	
2	Staging	In meters, It contains a scale of centimetres and millimetres	

24. Tape Measure (25) meter			
Nr.	Technical Requirement		Comply/Non-compliant (Description of any non-compliance)
<b>Component &amp; Specification</b>			
1	Display	(1.7) cm approx.	
2	Staging	In meters, It contains a scale of centimetres and millimetres	

25. Stopwatch			
Nr.	Technical Requirement		Comply/Non-compliant (Description of any non-compliance)
<b>Component &amp; Specification</b>			
1	The Frame Material of Manufacture	Reinforced plastic	
2	Usage	Manual stopwatch running up to 100-100 second digital, with (on / off) switches	
3	Features	SPLIT feature and dry battery	

26. Electric Air Pump			
Nr.	Technical Requirement		Comply/Non-compliant (Description of any non-compliance)
<b>Component &amp; Specification</b>			
1	Usage	To blow the ball	
2	Content	It contains a compressor inside and outside an indicator to measure the pumping force	
3	The Work	Works at (220 - 240) volts, (50) Hz	

26. Electric Air Pump			
Nr.	Technical Requirement		Comply/Non-compliant (Description of any non-compliance)
4	Attachment	The blower is connected on the one hand by the blower and the needle on the other which will connect the air between the blower and the ball through the blower	

27. Chess Base			
Nr.	Technical Requirement		Comply/Non-compliant (Description of any non-compliance)
Component & Specification			
1	Material of Manufacture	Made of leather.	
2	Dimensions	(40 × 40) cm approx.	
3	Usage and other parts	According to dimensions of the International Chess Federation and to be equipped with chess pieces suitable for the size of the board	

28. Chess Watch			
Nr.	Technical Requirement		Comply/Non-compliant (Description of any non-compliance)
Component & Specification			
1	The Frame Material of Manufacture	Reinforced wood or plastic.	
2	Usage	A chess stopwatch consisting of two clocks that operate alternately by means of two keys from the top and winded from the back by a manual spring surrounded by a bezel containing the hour hand, minute hand and indicator for ending the hours (end-of-clock indicator) according to the international law of chess.	



29. Big Funnel			
Nr.	Technical Requirement		Comply/Non-compliant (Description of any non-compliance)
Component & Specification			
1	Material of Manufacture	Made of reinforced plastic.	
2	Dimensions	The square base should not be less than (10) cm <sup>2</sup> , and the height should not be less than (23) cm.	

30. Intermediate Funnel			
Nr.	Technical Requirement		Comply/Non-compliant (Description of any non-compliance)
Component & Specification			
1	Material of Manufacture	Made of reinforced plastic.	
2	Dimensions	The square base should not be less than (10) cm <sup>2</sup> , and the height should not be less than (20) cm.	

31. Small Funnel			
Nr.	Technical Requirement		Comply/Non-compliant (Description of any non-compliance)
Component & Specification			
1	Material of Manufacture	Made of reinforced plastic.	
2	Dimensions	The square base should not be less than (13) cm <sup>2</sup> , and the height should not be less than (17) cm	

32. Dozens of Team Wear			
Nr.	Technical Requirement		Comply/Non-compliant (Description of any non-compliance)
Component & Specification			
1	Material of manufacture	Made of polyester, openwork fabric.	
2	Dozen	Dozens of (12) sport blouse.	
3	Color	Phosphoric	
4	Measurements	Several Measurements: Large, Medium, Small.	



33. Jump Rope		
Nr.	Technical Requirement	Comply/Non-compliant (Description of any non-compliance)
<b>Component &amp; Specification</b>		
1	Material of manufacture	The Cord: made of hemp fibres or rubber. The Handle: Made of wood or plastic covered with sponge.

34. Gymnastic Mattress		
Nr.	Technical Requirement	Comply/Non-compliant (Description of any non-compliance)
<b>Component &amp; Specification</b>		
1	Material of manufacture	Made of pressed sponges.
2	Dimensions	Width: (1) m approx. Length: (2) m approx. Thickness: $\geq$ (5) cm Weight: $\geq$ (9) kg. Screwing up till Pull (80).
3	General Description	Have a face of skin or shader. Equipped with (4) Handles from both sides for easy carrying, applied with a zipper closure.

35. Table Tennis Nets with Legs		
Nr.	Technical Requirement	Comply/Non-compliant (Description of any non-compliance)
<b>Component &amp; Specification</b>		
1	Shape	One eye in a square shaped grid
2	Upper and lower limbs	A double layer of linen top about (1.5) cm. approx. wide, and from the bottom passes a thread for fastening without a double layer.
3	Attachment	(2) Hollow metal rolls do not affect the player's movement and fix the net on the table body.
4	Notes	According to the international legal dimensions.

36. Metal Box for Placing Balls			
Nr.	Technical Requirement		Comply/Non-compliant (Description of any non-compliance)
<b>Component &amp; Specification</b>			
1	Material of manufacture	Made of stainless steel, coated with thermal coating, pipe ends.	
2	Shape & Description	The shape of the basket is cubic, and all the sides of the iron angle (2.5) cm dimensions approx. and each face contains a metal mesh and one eye in the network in the form of a square, so that the pipes and mesh for all the face well soldered except the upper face.	
3	Upper Face	The upper face opened and closed easily with a lock or key.	
4	Basket	Dimensions of the basket: (1)m × (1)m × (0.7) m approx.	

37. Dozens of Stick Relay			
Nr.	Technical Requirement		Comply/Non-compliant (Description of any non-compliance)
<b>Component &amp; Specification</b>			
1	Material & Description	Made of aluminium to be cylindrical and smooth.	
2	Dimensions	Length (280 - 300) mm approx. Perimeter (120 - 130) mm approx.	
3	Weight	Not less than (50) g.	

38. Digital scale			
Nr.	Technical Requirement		Comply/Non-compliant (Description of any non-compliance)
<b>Component &amp; Specification</b>			
1	General Description	Digital scale used to weigh human. Suitable base for standing and measuring human weight. With a suitable base for standing. Battery operated.	
2	Material of manufacture	Made of Metal, reinforced plastic or strong glass.	
3	Screen Measurement	Digital display shows the weight clearly.	
4	Weight Measurement	Weight measurement index for load (150) kg or more (Capable to measure weight till (150) kg. or more.)	



39. Medical Balls for Males			
Nr.	Technical Requirement		Comply/Non-compliant (Description of any non-compliance)
Component & Specification			
1	Material of Manufacture	Made of leather or reinforced plastic (PVC).	
2	Weight and Shape	Weighing not less than (2000) g, round shape and can be inflated to increase the size to suit all games.	

40. Medical Balls for Females			
Nr.	Technical Requirement		Comply/Non-compliant (Description of any non-compliance)
Component & Specification			
1	Material of Manufacture	Made of leather or reinforced plastic (PVC).	
2	Weight and Shape	Weighing not less than (1500) g, round shape and can be inflated to increase the size to suit all games.	

41. Sit and Reach Flexibility Box			
Nr.	Technical Requirement		Comply/Non-compliant (Description of any non-compliance)
Component & Specification			
1	Material of Manufacture & Description	Made of metal that has two side slots for easy portability and covered with a plastic frame. In the middle of it, is a tongue (extruding surface plate) of length (23) cm approx. Tongue length with box width (64) cm approx. Inscribed with an aluminium ruler and numbers engraved on it. It measures from zero to (51) cm approx. from the side of the tongue.	
2	Dimensions	Height with base (26) cm approx. Width (41) cm Length (56) cm approx.	
3	Paint	Thermal greased (powdered)	
4	Warranty	Warranty not less than one year.	
5	Notes	According to the international legal dimensions. According to the reference image bellow.	

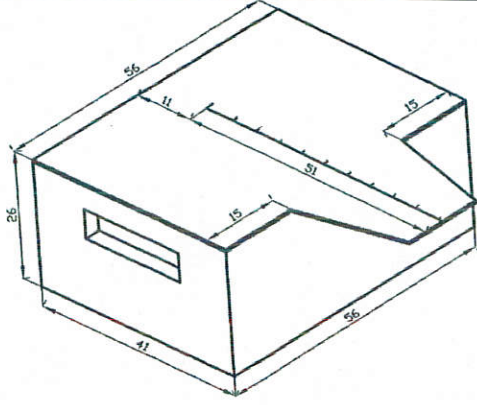
41. Sit and Reach Flexibility Box		
Nr.	Technical Requirement	Comply/Non-compliant (Description of any non-compliance)
		

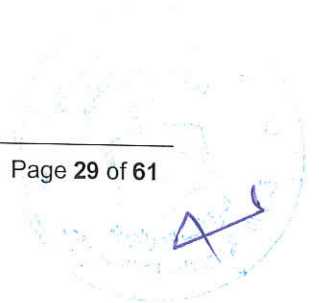



### 1.4.3 FORM 3 – Bill of Quantities (BoQ) (جدول الكميات)

The Purchaser reserves the right to change the quantities by adding/reducing the quantity by 20% from all schools combined. Any such change of quantities shall not affect the unit prices of any other item which is not cancelled, and would only impact the total amount of the Bid.

The Bidder shall deliver the complete scope for all items for all four schools:

- The Bidder shall complete the BoQ fully; and
- If an individual item is not completed in the bill, the highest unit price for the same item in another bill shall be inserted.
- If a complete bill is not filled in, the Bid shall be rejected.

**The full Bill of Quantities for the 4 schools under the EU Component are covered in the section below .**



1.4.3.1 EU1 Al Nahda School

Item No.	Description of Items	Unit	Quantity	Total Cost (JOD)		Taxes and Customs (JOD)	
				Unit Price	Total Price	Unit Price	Total Price
1	Football or soccer ball كرة قدم	each	10				
2	Volleyball الكرة الطائرة	each	5				
3	Volleyball stands قوائم الكرة الطائرة	pair	1				
4	Volleyball net شبكة الكرة الطائرة	each	2				
5	Basketball for male كرة سلة للذكور	each	8				
6	Basketball for female كرة سلة للإناث	each	8				
7	Handball for male يد للذكور	each`	5				
8	Handball for female كرة يد للإناث	each	5				
9	Pair of handball nets شبكة كرة يد	pair	1				
10	Tablet (Discus) for male 1500 غرام (1.5) kg قرص وزن 1500 غرام للذكور	each	3				
11	Tablet (Discus) for female 1000 غرام (1) kg قرص وزن 1000 غرام للإناث	each	3				
12	Metal ball for male كرة معدنية للذكور	each	2				
13	Metal ball for female كرة معدنية للإناث	each	2				
14	Javelin for male رمح للذكور	each	3				
15	Javelin for female رمح للإناث	each	3				
16	Pair of table tennis rackets - مضارب كرة الطاولة - زوج	pair	5				
17	Table tennis طاولة تنس	each	1				
18	Dozens of table tennis balls كرات طاولة تنس	dozen	10				



Item No.	Description of Items	Unit	Quantity	Total Cost (JOD)		Taxes and Customs (JOD)	
				Unit Price	Total Price	Unit Price	Total Price
19	مضرب ريشة طائرة طائرة badminton rackets	pair	8				
20	قوائم ريشة طائرة طائرة badminton stands	pair	1				
21	شبكة ريشة طائرة طائرة badminton net	each	4				
22	ريشة طائرة طائرة shuttlecocks	dozen	3				
23	متر كركر 50 متر Tape measure (50) meter	each	3				
24	متر كركر 25 متر Tape measure (25) meter	each	3				
25	ساعة توقيت Stopwatch	each	5				
26	منفاخ كهربائي Electric air pump	each	2				
27	رقعة شطرنج Chess base	each	4				
28	ساعة شطرنج Chess watch	each	4				
29	قمع كبير Big funnel	each	10				
30	قمع وسط وسم Intermediate funnel	each	10				
31	قمع صغير Small funnel	each	10				
32	طقم نمايز - طقم team wear	dozen	2				
33	حبل وثب Jump rope	each	20				
34	فرشة جيمار Gymnastic mattress	each	6				
35	شبكة تنس طاولة مع الارجل Table tennis nets with legs	each	4				
36	صندوق معدني لوضع الكرات Metal box for placing balls	each	1				
37	عصا التتابع عصا stick relay	dozen	8				
38	ميزان رقمي Digital scale	each	1				

Item No.	Description of Items	Unit	Quantity	Total Cost (JOD)		Taxes and Customs (JOD)	
				Unit Price	Total Price	Unit Price	Total Price
39	كرات طبية / للذكور Medical balls for males	each	5				
40	كرات / طبية للإناث Medical balls for females	each	5				
41	صندوق الجلوس والوصول إلى صندوق المرونة Sit and reach flexibility box / المرونة	each	5				
<b>Total Price Excluding Taxes and Customs (JOD)</b>							
<b>Grand Total Including Taxes and Customs (JOD)</b>							

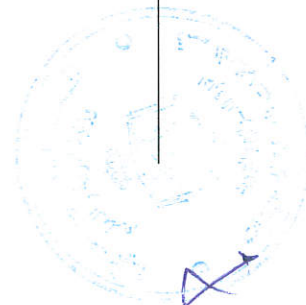



1.4.3.2 EU2 Howwara School

Item No.	Description of Items	Unit	Quantity	Total Cost (JOD)		Taxes and Customs (JOD)	
				Unit Price	Total Price	Unit Price	Total Price
1	Football or soccer ball كرة قدم	each	10				
2	Volleyball stands الكرة الطائرة	each	5				
3	Volleyball stands قوائم الكرة الطائرة	pair	1				
4	Volleyball net شبكة الكرة الطائرة	each	2				
5	Basketball for male كرة سلة للذكور	each	8				
6	Basketball for female كرة سلة للإناث	each	8				
7	Handball for male كرة يد للذكور	each`	5				
8	Handball for female كرة يد للإناث	each	5				
9	Pair of handball nets شبكة كرة يد	pair	1				
10	Tablet (Discus) for male قرص وزن 1500 غرام (1.5) kg للذكور	each	3				
11	Tablet (Discus) for female قرص وزن 1000 غرام (1) kg للإناث	each	3				
12	Metal ball for male كرة معدنية للذكور	each	2				
13	Metal ball for female كرة معدنية للإناث	each	2				
14	Javelin for male رمح للذكور	each	3				
15	Javelin for female رمح للإناث	each	3				
16	Pair of table tennis rackets مضارب كرة الطاولة - زوج	pair	5				
17	Table tennis طاولة تنس	each	1				
18	Dozens of table tennis balls كرات طاولة تنس	dozen	10				

Item No.	Description of Items	Unit	Quantity	Total Cost (JOD)		Taxes and Customs (JOD)	
				Unit Price	Total Price	Unit Price	Total Price
19	مضرب ريشة طائرة: badminton rackets	pair	8				
20	قوائم ريشة طائرة: badminton stands	pair	1				
21	شبكة ريشة طائرة: Badminton net	each	4				
22	ريشة طائرة: Dozens of shuttlecocks	dozen	3				
23	متر كركر 50 متر: Tape measure (50) meter	each	3				
24	متر كركر 25 متر: Tape measure (25) meter	each	3				
25	ساعة توقيت: Stopwatch	each	5				
26	منفاخ كهربائي: Electric air pump	each	2				
27	رقعة شطرنج: Chess base	each	4				
28	ساعة شطرنج: Chess watch	each	4				
29	قمع كبير: Big funnel	each	10				
30	قمع وسط: Intermediate funnel	each	10				
31	قمع صغير: Small funnel	each	10				
32	طقم تمايز - طقم فريق: Dozens of team wear	dozen	2				
33	حبل وثب: Jump rope	each	20				
34	فرشة جيمناز: Gymnastic mattress	each	6				
35	شبكة تنس طاولة مع الأرجل: Table tennis nets with legs	each	4				
36	صندوق معدني لوضع الكرات: Metal box for placing balls	each	1				
37	عصا التتابع: Dozens of stick relay	dozen	8				
38	ميزان رقمي: Digital scale	each	1				



Item No.	Description of Items	Unit	Quantity	Total Cost (JOD)		Taxes and Customs (JOD)	
				Unit Price	Total Price	Unit Price	Total Price
39	كرات طبية / للذكور Medical balls for males	each	5				
40	كرات / طبية للإناث Medical balls for females	each	5				
41	صندوق الجلوس والوصول إلى المرونة Sit and reach flexibility box	each	5				
<b>Total Price Excluding Taxes and Customs (JOD)</b>							
<b>Grand Total Including Taxes and Customs (JOD)</b>							



1.4.3.3 EU17 Hakama School

Item No.	Description of Items	Unit	Quantity	Total Cost (JOD)		Taxes and Customs (JOD)	
				Unit Price	Total Price	Unit Price	Total Price
1	Football or soccer ball كرة قدم	each	10				
2	Volleyball الكرة الطائرة	each	5				
3	Volleyball stands قوائم الكرة الطائرة	pair	1				
4	Volleyball net شبكة الكرة الطائرة	each	2				
5	Basketball for male كرة سلة للذكور	each	8				
6	Basketball for female كرة سلة للإناث	each	8				
7	Handball for male كرة يد للذكور	each`	5				
8	Handball for female كرة يد للإناث	each	5				
9	Pair of handball nets شبكة كرة يد	pair	1				
10	Tablet (Discus) for male قرص وزن 1500 غرام (1.5) kg للذكور	each	3				
11	Tablet (Discus) for female قرص وزن 1000 غرام (1) kg للإناث	each	3				
12	Metal ball for male كرة معدنية للذكور	each	2				
13	Metal ball for female كرة معدنية للإناث	each	2				
14	Javelin for male رمح للذكور	each	3				
15	Javelin for female رمح للإناث	each	3				
16	Pair of table tennis rackets مضارب كرة الطاولة - زوج	pair	5				
17	Table tennis طاولة تنس	each	1				
18	Dozens of table tennis balls كرات طاولة تنس	dozen	10				



Item No.	Description of Items	Unit	Quantity	Total Cost (JOD)		Taxes and Customs (JOD)	
				Unit Price	Total Price	Unit Price	Total Price
19	مضرب ريشة طائرة	pair	8				
20	قوائم ريشة طائرة	pair	1				
21	شبكة ريشة طائرة	each	4				
22	ريشة طائرة	dozen	3				
23	متر كركر 50 meter	each	3				
24	متر كركر 25 meter	each	3				
25	ساعة توقيت	each	5				
26	مفاح كهربائي	each	2				
27	رقعة شطرنج	each	4				
28	ساعة شطرنج	each	4				
29	قمع كبير	each	10				
30	قمع وسط	each	10				
31	قمع صغير	each	10				
32	طقم نمايز - طقم فريق	dozen	2				
33	حبل وثب	each	20				
34	فرشة جيمار	each	6				
35	شبكة تنس طاولة مع الارجل	each	4				
36	صندوق معدني لوضع الكرات	each	1				
37	عصا التتابع	dozen	8				
38	ميزان رقمي	each	1				

Item No.	Description of Items	Unit	Quantity	Total Cost (JOD)		Taxes and Customs (JOD)	
				Unit Price	Total Price	Unit Price	Total Price
39	كرات طبية / للذكور Medical balls for males	each	5				
40	كرات / طبية للإناث Medical balls for females	each	5				
41	صندوق الجلوس والوصول إلى مرونة Sit and reach flexibility box / المرونة	each	5				
<b>Total Price Excluding Taxes and Customs (JOD)</b>							
<b>Grand Total Including Taxes and Customs (JOD)</b>							

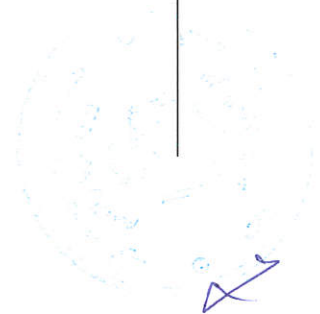



1.4.3.4 EU18 Hay Al Dobbat

Item No.	Description of Items	Unit	Quantity	Total Cost (JOD)		Taxes and Customs (JOD)	
				Unit Price	Total Price	Unit Price	Total Price
1	Football or soccer ball كرة قدم	each	10				
2	Volleyball الكرة الطائرة	each	5				
3	Volleyball stands قوائم الكرة الطائرة	pair	1				
4	Volleyball net شبكة الكرة الطائرة	each	2				
5	Basketball for male كرة سلة للذكور	each	8				
6	Basketball for female كرة سلة للإناث	each	8				
7	Handball for male كرة يد للذكور	each`	5				
8	Handball for female كرة يد للإناث	each	5				
9	Pair of handball nets شبكة كرة يد	pair	1				
10	Tablet (Discus) for male قرص وزن 1500 غرام (1.5) kg للذكور	each	3				
11	Tablet (Discus) for female قرص وزن 1000 غرام (1) kg للإناث	each	3				
12	Metal ball for male كرة معدنية للذكور	each	2				
13	Metal ball for female كرة معدنية للإناث	each	2				
14	Javelin for male رمح للذكور	each	3				
15	Javelin for female رمح للإناث	each	3				
16	Pair of table tennis rackets مضارب كرة الطاولة - زوج	pair	5				
17	Table tennis طاولة تنس	each	1				
18	Dozens of table tennis balls كرات طاولة تنس	dozen	10				

Item No.	Description of Items	Unit	Quantity	Total Cost (JOD)		Taxes and Customs (JOD)	
				Unit Price	Total Price	Unit Price	Total Price
19	مضرب ريشة طائرة مضرب ريشة طائرة	pair	8				
20	قوائم ريشة طائرة قوائم ريشة طائرة	pair	1				
21	شبكة ريشة طائرة شبكة ريشة طائرة	each	4				
22	ريشة طائرة dozens of shuttlecocks	dozen	3				
23	متر كركر 50 متر Tape measure (50) meter	each	3				
24	متر كركر 25 متر Tape measure (25) meter	each	3				
25	ساعة توقيت Stopwatch	each	5				
26	منفاخ كهربائي Electric air pump	each	2				
27	رقعة شطرنج Chess base	each	4				
28	ساعة شطرنج Chess watch	each	4				
29	قمع كبير Big funnel	each	10				
30	قمع وسط وسمق Intermediate funnel	each	10				
31	قمع صغير Small funnel	each	10				
32	طقم تمايز - طقم فريق Dozens of team wear	dozen	2				
33	حبل وثب Jump rope	each	20				
34	فرشة جيمناز Gymnastic mattress	each	6				
35	شبكة تنس طاولة مع الارجل Table tennis nets with legs	each	4				
36	صندوق معدني لوضع الكرات Metal box for placing balls	each	1				
37	عصا التتابع عصا التتابع	dozen	8				
38	ميزان رقمي Digital scale	each	1				



Item No.	Description of Items	Unit	Quantity	Total Cost (JOD)		Taxes and Customs (JOD)	
				Unit Price	Total Price	Unit Price	Total Price
39	Medical balls for males / كرات طبية / للذكور	each	5				
40	Medical balls for females / كرات / طبية للإناث	each	5				
41	Sit and reach flexibility box / صندوق الجلوس والوصول إلى المرونة	each	5				
<b>Total Price Excluding Taxes and Customs (JOD)</b>							
<b>Grand Total Including Taxes and Customs (JOD)</b>							

<b>Grand Total Price Excluding Taxes and Customs (JOD)</b>	
<b>Grand Total Price Including Taxes and Customs (JOD)</b>	

#### 1.4.4 FORM 4 – Warranty Confirmation Form (نموذج التعهد بتقديم الكفالة)

*[To be completed by the Bidder and by at least one member of the Bidder's JV]*

Bidder's Legal Name: *[Insert]*

Date: *[Insert]*

JV Member's Legal Name: *[Insert]*

NCB No. 510929 Procurement of Sports Equipment for School Construction Programme-  
Phase 1

Page *[Insert]* of *[Insert]* pages

We confirm that, if awarded the Contract, and upon delivery a warranty certificate will be provided as per the conditions of the contract.

We further confirm that the warranty shall cover all products supplied under this contract and we confirm to repair and replace defective components, which will be no additional charge to the Ministry of Education.

Title of the person signing the Bid *[Insert complete title of the person signing the Bid]*

Signature of the person named above *[Signature of the person named above]*

Date signed *[Insert date of signing]* day of *[Insert month]* *[Insert year]*





1.5 Ministry of Education Ministry of Education Letter on Taxation (كتاب وزارة التربية والتعليم بخصوص الضرائب)

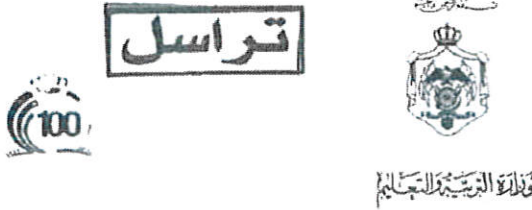

٤٩٢٥  
٢٩  
٢٥/١

Subject: Tender No. (1/2019KFW) for the preparation of studies, designs, tender documents and supervisions of the execution of the (18) schools in various sites within the Kingdom of Jordan funded through KfW for both Components, EU and FC and SCP I, II, III, IV, and SCL.

49/170/23895 الرقم  
30/6/2021 التاريخ  
الموافق

Your excellency Minister of Public Works and Housing.

Reference is made to KfW's official letter (STIS) dated 25 May 2021 sent to His Excellency Minister of Finance and a copy to Minister of International Planning and International Cooperation, MoE:

1. is committed to bear (reimburse) all sales taxes incurred in the contracts financed within the project within a period of 30 days after the issuance of the respective invoice for the contractors after it is certified from the relevant authorities
2. will bear and pay any customs and duties related to the project directly to the contractor (reimburse) within 30 days of the respective Invoice (to prevent any possible delay within the timeline of the construction phase).

All other taxes, duties, levies and fees payable by the Consultant (respectively Contractor), its Sub-consultants and Experts inside and outside the Employer's country shall be included in the overheads and reflected in the unit prices.

MoE and MoPWH, as the Project Execution Agency, shall explicitly specify that the tax sales, customs and duties shall be paid to the Consultant, supplier and construction companies as a separate part of the tender documents. This shall be for both Components, German Financial Cooperation (FC) and European Union (EU), and School Construction Programmes (SCP) including SCP I & II, SCP III & IV and School Construction Loan (SCL). This shall be the case if this Ministry (MoE) does not get a tax exemption from all Local taxes including sales tax, stamps, customs and duties that might be induced on the construction of the above mentioned Programmes.

Thank you for your cooperation,

Minister of Education  
Prof. Dr. Mohammad Abu Qudais

Copies:  
CC: SGs at MOE  
CC: KfW office in Jordan  
CC: Consultant Dorsch Offices at MoPWH

٢٥

## 1.6 Eligibility in KfW-Financed Procurement

1. To the exception of any equipment or any sector which is subject to an embargo by the United Nations, the European Union or Germany, all goods, works, plants, consulting services and non-consulting services are eligible for KfW financing regardless of the country of origin of the contractor, supplier, subcontractor, consultant or subconsultant inputs or resources used in the implementation processes. The Contracting Authority means the Purchaser, the Employer, the Client or the Project Executing Agency as the case may be, for the procurement of goods, works, plants, consulting services or non-consulting services.
2. Natural or legal persons (including board members or legal representatives, all members of a joint venture or any of their suppliers, contractors, subcontractors, consultants or subconsultants) shall not be awarded a KfW-financed contract if, on the date of submission of an application, a bid or a proposal, or on the date of award of a contract, they:
  - 2.1 are bankrupt or being wound up or ceasing their activities, are having their activities administered by the courts, have entered into receivership, or are in any analogous situation arising from a similar procedure;
  - 2.2 have been:
    - (a) convicted, within the past five years by a court decision, which has the force of *res judicata* in the country where the contract is implemented, of fraud, corruption or of any other offense committed during a procurement process or performance of a contract, unless they provide supporting information together with their Declaration of Undertaking (Form available as Appendix to the Application, Bid or Proposal Submission Form) which shows that this conviction is not relevant in the context of this contract and that adequate compliance measures have been taken in reaction;
    - (b) subject to an administrative sanction within the past five years by the European Union or by national authorities either in the country of the Contracting Authority or of KfW, for fraud, corruption or for any other offense committed during a procurement process or performance of a contract, unless they provide supporting information together with their Declaration of Undertaking (Form available as Appendix to the Application, Bid or Proposal Submission Form) which shows that this sanction is not relevant in the context of this contract and that adequate compliance measures have been taken in reaction;
    - (c) convicted, within the past five years by a court decision, which has the force of *res judicata*, of fraud, corruption or of any other offense committed during the procurement process or performance of an KfW-financed contract;
  - 2.3 are listed for financial sanctions by the United Nations, the European Union and/or Germany for the purposes of fight-against-terrorist financing or threat to international peace and security. This criterion of exclusion is also applicable to legal persons, whose majority of shares are held or factually controlled by a listed natural or legal person;
  - 2.4 have been subject within the past five years to a contract termination fully settled against them for significant or persistent failure to comply with their contractual obligations during contract performance, unless this termination was challenged and the dispute resolution is still pending or has not confirmed a full settlement against them;
  - 2.5 have not fulfilled their fiscal obligations regarding payments of taxes in accordance with the legal provisions of either the country where they are constituted or the Contracting Authority's country;



- 2.6 are subject to an exclusion decision of the World Bank and are listed on the website <http://www.worldbank.org/debarr>, unless they provide supporting information together with their Declaration of Undertaking (Form available as Appendix to the Application, Bid or Proposal Submission Form) which shows that this exclusion is not relevant in the context of this contract and that adequate compliance measures have been taken in reaction;
- 2.7 have created false documents or committed misrepresentation in documentation requested by the Contracting Authority as part of the procurement process of this Contract.
3. State-owned entities may compete only if they can establish that they (i) are legally and financially autonomous, and (ii) operate under commercial law. To be eligible, a state-owned entity shall establish to KfW's satisfaction, through all relevant documents, including its Charter and other information KfW may request, that it: (i) is a legal entity separate from their state (ii) does not currently receive substantial subsidies or budget support; (iii) operates like any commercial enterprise, and, inter alia, is not obliged to pass on its surplus to their state, can acquire rights and liabilities, borrow funds and be liable for repayment of its debts, and can be declared bankrupt.



## PART 2 – Supply Requirements (المواصفات المطلوبة)

### 2.1 Scope of Work (نطاق الأعمال)

The scope of work is to supply the specified sports equipment i.e. goods according to the requirements and specifications in this RfQ for the following schools (Al Nahda Schools (in Irbid) – Howarra Schools (in Irbid) – Hakama Schools (in Irbid) - Hay Al Dobbat Schools (in Mafraq). The Goods shall be delivered to the final delivery location within the duration shown in Section 2.2.

The bidder shall complete the scope of work for all items to submit a bid for, partial bids are not permitted and shall lead to exclusion.

The supplier shall be responsible for all procedures to procure, coordinate, enter the items and their spare parts (if any) into Jordan and deliver and assemble them at the specified location. The purchaser will provide the necessary confirmations for manufacturers if necessary. The Incoterms for this Contract are DDP (Delivered Duty Paid), in its 2010 version.

The supplier shall obtain all permits and licenses necessary to import the items specified in the bills of quantity where this is applicable.

The supplier shall be responsible for the specified Goods up to delivery and acceptance. Only quantities delivered and handed over in good condition as specified will be accepted and paid for.

The delivery of the items shall be in accordance with the construction timeline of the schools i.e. the delivery location and schedule as specified in section 2.2. The supplier shall be responsible for the Goods from the point of manufacture of the goods up to their delivery, installation and taking over at the site.

The Supplier shall provide the Manufacturers' standard warranty or warranties against defects in manufacture, which shall not be less than 12 months this applies for the items that have warranty as mentioned in the technical schedules.





## 2.2 Delivery Schedule (جدول التسليم)

School Delivery Schedule for XXXX Sports Equipment		Construction			Programme	
School Name	Latest Delivery at Destination	Location of delivery	Governorate	Notes		
EU1 Al Nahda School	90 Days from contract signature	School Building	Irbid	To the required room		
EU2 Howwara School	90 Days from contract signature	School Building	Irbid	To the required room		
EU17 Hakama School	90 Days from contract signature	School Building	Irbid	To the required room		
EU18 Hay Al Dobbat School	90 Days from contract signature	School Building	Al Mafraq	To the required room		



### 2.3 List of School Locations for Deliveries (قائمة بمواقع المدارس لعمليات التسليم)

The locations of the individual schools for the deliveries are as specified in table above.

No.	Name	Govern- orate	Directorate	Lat.	Long.	Village	Village No.	Basin	Basin No.	Neighbor- hood	Plot's No.
EU1	Al Nahda Secondary Mixed School النهضة الثانوية المختلطة	Irbid	Directorate of Education for Ramtha - مديرية التربية والتعليم - منطقة الرمثا	32.56112991	35.99343968	Ramtha	261	Al Duwar	28	between 8th & 9th بين الحي التاسع والحي الثامن	359
EU2	Howwara Basic Mixed School حوارة الأساسية المختلطة	Irbid	Directorate of Education Qasabet Irbid مديرية التعليم - قصبه اربد	32.52364943	35.9104444	Huwara	189	Al Joor Al Sharqi	27	Howwara	538
EU17	Hakama Mixed Secondary حكما الثانوية للبنات	Irbid	Directorate of Education Qasabet Irbid مديرية التعليم - قصبه اربد	32.59032534	35.87748074	Hikma	188	A'sem	4	Hakama	678
EU18	Hai Al Dobbat Mixed Secondary حي الضباب الثانوية المختلطة	Mafrq	Directorate of Education Qasabet Al Mafrq مديرية التعليم - قصبه المفرق	32.34655718	36.20854715	Al Mafrq	423	Al Mafrq Al Shmali	2	Hai al husain	16

## 2.4 Technical Specifications (المواصفات الفنية)

- Technical Conditions :
  - The brand and models provided for the supplies shall be clearly identified in the compliance sheets.
  - Upon delivery, the Supplier shall provide full instruction manuals in English, which describe the correct methods and procedures necessary to install, assemble, commissioning and use the items supplied in accordance with best practice. Conformity to standard certificate(s) may be supplied at time of tender where these certificate(s) must be issued from a third party and be valid and up to date.
- Warranty:
  - The Supplier shall provide the Manufacturers' standard warranty or warranties against defects in manufacture, which shall not be less than 12 months this applies for the items that have warranty as mentioned in the technical schedules.
- Delivery:
  - Latest delivery shall be 90 days (DDP) from the Contract Signature, and to each school as per Section 2.2 "Delivery Schedule".





## PART 3 – Contract (العقد)

### 3.1 Contract Terms and Conditions (الشروط والأحكام)

1. The Date of Commencement of this agreement shall be 5 days following the signature of the Contract Agreement by both Parties, No-Objection from KfW Development Bank (KfW), and if required, approval of the Contract by relevant authorities of the Country.
2. The EU sections of this Contract are financed by the European Union through KfW from their Regional Trust Fund in Response to the Syrian Crisis (EUTF).
3. The “Consultant” for the purposes of this Purchase Order means the Joint Venture Dorsch International Consultants GmbH as the Leading Partner, with AHT GROUP AG and DAR AL OMRAN Planning, Architecture and Engineering.
4. All Payments shall be made in **Jordanian Dinar** within sixty (60) days of presentation of an invoice or request for payment supported by a certificate from the Purchaser declaring that the Goods have been delivered and that all other contracted Services have been performed. Partial payment shall be allowed against an invoice or request for payment and the delivered, installed and accepted Goods (certificate from the Purchaser).
5. The Supplier shall not be exempt from any duties, taxes, fees, levies and other charges applicable in and outside the Purchaser’s country. The sales tax and custom duties shall be priced separately in the Bills of Quantities and shall be listed separately in all requests for payment and will be reimbursed by the Purchaser. **The sales tax and customs duties will be reimbursed, in the certified actual amounts paid, by the Ministry of Education within a period of 90 days after certification by the respective authority.**

#### Withholding tax (where this is applicable):

- The schools funded by the (EU), withholding tax (If applicable) will be reimbursed with the final payment certificate by the Ministry of Education.
- The schools funded by the German government are exempt from the Withholding Tax (WHT) as per cabinet decision - letter no. (13A/11/1/51342) Dated September 17th, 2023, however, should this change WHT, will be reimbursed by MoE with the final payment certificate by the Ministry of Education.

Under the terms of the financing agreement with the European Union, the European Union cannot pay any sales taxes, customs, and other levies..

6. Payment to the Supplier of the amounts due shall be made into the following bank account:

*[Insert bank account details at the time of contract signing]*

.....  
.....  
.....  
.....  
.....

7. Any reimbursements in respect to the guarantees, if required, shall be effected to a .....  
*[Special account No. to be provided by MoE ..... for the account of Ministry of Education, Hashemite Kingdom of Jordan.*



8. An official letter from the Ministry of Education committing them to reimburse all customs duties and sales taxes is attached.
9. The governing and communication language shall be English.
10. The governing law shall be the law of Jordan.
11. The Supplier shall, subject to the Purchaser's compliance with Term/Condition no. 12, indemnify and hold harmless the Purchaser and its employees and officers from and against any and all suits, actions or administrative proceedings, claims, demands, losses, damages, costs, and expenses of any nature, including attorney's fees and expenses, which the Purchaser may suffer as a result of any infringement or alleged infringement of any patent, utility model, registered design, trademark, copyright, or other intellectual property right registered or otherwise existing at the date of the Contract by reason of:
  - a) The delivery of the Goods by the Supplier or the use of the Goods in the country where the Sites are located; and
  - b) The sale in any country of the products produced by the Goods.
12. Such indemnity shall not cover any use of the Goods or any part thereof other than for the purpose indicated by or to be reasonably inferred from the Contract. The liability of the Supplier under this clause shall not exceed the amount of this supply agreement.
13. If any proceedings are brought or any claim is made against the Purchaser arising out of the matters, the Purchaser shall promptly give the Supplier a notice thereof, and the Supplier may at its own expense and in the Purchaser's name conduct such proceedings or claim and any negotiations for the settlement of any such proceedings or claim.
14. If the Supplier fails to notify the Purchaser within twenty-eight (28) days after receipt of such notice that it intends to conduct any such proceedings or claim, then the Purchaser shall be free to conduct the same on its own behalf.
15. The Purchaser shall, at the Supplier's request, afford all available assistance to the Supplier in conducting such proceedings or claim, and shall be reimbursed by the Supplier for all reasonable expenses incurred in so doing.
16. The Supplier shall maintain, for so long as may be necessary to cover its obligations and liabilities under or in connection with this Agreement, insurances, including vehicle insurance, with limits of indemnity of not less than the sums stated in **Clause 12** above, for any one occurrence or series of occurrences arising out of any one event in respect of the Supplier's liability. the Supplier's public/third party liability, arising out of or in connection with the Supply Services and any other risks or events stipulated in the Agreement or required by the laws of the Country. Transport insurance for Goods shall be at least 110% (one hundred and ten percent) of the Accepted Contract Amount and shall cover "all risks" basis and should include war risks and strike clauses.
17. The Supplier shall produce for inspection documentary evidence that the insurances required by **Clause 16** are being properly maintained when required to do so by the Consultant The Purchaser, by notice sent to the Supplier, may terminate the Contract, in whole or in part, at any time for its convenience. The notice of termination shall specify that termination is for the Purchaser's convenience, the extent to which performance of the Supplier under the Contract is terminated, and the date upon which such termination becomes effective.
18. Except in cases of criminal negligence or wilful misconduct,
  - a) The Supplier shall not be liable to the Purchaser, whether in contract, tort, or otherwise, for any indirect or consequential loss or damage, loss of use, loss of production, or loss of profits or interest costs, provided that this exclusion shall not apply to any obligation of the Supplier to pay liquidated damages to the Purchaser; and





- b) The aggregate liability of the Supplier to the Purchaser, whether under the Contract, in tort or otherwise, shall not exceed the total Contract Price, provided that this limitation shall not apply to the cost of repairing or replacing defective equipment, or to any obligation of the Supplier to indemnify the purchaser with respect to patent infringement.
19. The Goods that are complete and ready for shipment within twenty-eight (28) days after the Supplier's receipt of notice of termination shall be accepted by the Purchaser at the Contract terms and prices. For the remaining Goods, the Purchaser may elect:
- a) To have any portion completed and delivered at the Contract terms and prices; and/or
- b) To cancel the remainder and pay to the Supplier a mutually agreed amount for partially completed Goods and Related Services and for materials and parts previously procured by the Supplier.
20. Termination of this Agreement howsoever arising shall be without prejudice to the rights and remedies of either Party in relation to any negligence, omission or default of the other, prior to such termination.
21. In performing his services according to this Agreement, the Supplier will not provide bribes, gifts, direct or indirect payments or kickbacks of any kind, or will offer to provide or pay such, to employees or representatives of the Consultant or the Purchaser or authority or government officials or political parties for purposes of influencing any act or decision or inducing such authority or government official to use his influence with the authority, government or instrumentality thereof to effect or influence any act or decision, or which are otherwise illegal under any applicable law and, further, shall comply with the Declaration of Undertaking signed and stamped by him and attached as annex hereto.
22. If a Force Majeure<sup>6</sup> situation arises, the Supplier shall promptly notify the Purchaser in writing of such condition and the cause thereof. Unless otherwise directed by the Purchaser in writing, the Supplier shall continue to perform its obligations under the Contract as far as is reasonably practical and shall seek all reasonable alternative means for performance not prevented by the Force Majeure event.
23. In the case of a dispute between the Purchaser and a Supplier, the dispute shall be referred to adjudication or arbitration in accordance with the laws of the Purchaser's country.
24. Price Adjustments are not allowed under this Contract.
25. Within 14 (Fourteen) days after receipt of the notification of award from the Purchaser, the successful Supplier shall furnish to the Purchaser a Performance Security in the form of a bank guarantee in an amount of 10% (ten percent) of the Contract price. The performance security shall be denominated in Jordanian Dinar. The sample form of the Performance Bank Guarantee is provided in Section 3.4.
26. The Performance Bank Guarantee to be provided by the successful Supplier shall be an unconditional bank guarantee issued either (a) by a reputable bank located in the country of the Purchaser, or (b) by a foreign bank acceptable to the Purchaser.
27. Failure of the successful Supplier to comply with the requirements of this Performance Guarantee shall constitute sufficient grounds for the annulment of the award.
28. The Performance Security shall be discharged by the Purchaser and returned to the Supplier not later than twenty-eight (28) days following the data of the Completion of the Supplier's performance obligations under the Contract.
29. If the Supplier fails to deliver any or all of the Goods by the Date(s) of delivery or perform the Related Services within the period specified in the Contract, the Purchaser may without

<sup>6</sup> "Force Majeur" definition as per the KfW Procurement Guidelines





prejudice to all its other remedies under the Contract, deduct from the Contract Price, as liquidated damages, a sum equivalent to the percentage specified in the table below of the delivered price of the delayed Goods or unperformed Services for each week or part thereof of delay until actual delivery or performance, up to a maximum deduction of the percentage specified in the table below. Once the maximum is reached, the Purchaser may terminate the Contract. These damages shall not relieve the Supplier from his obligation to complete the Services, or from any other duties, obligations, or responsibilities which he may have under the Contract.

<b>Delay damages for the Services</b>	<b>0.5% per week or partial week for the Delayed Services.</b>
<b>Maximum amount of delay damages</b>	<b>10% of the final Contract Price.</b>



## الشروط والأحكام

1. يجب أن يكون تاريخ أمر المباشرة بعد 5 أيام من توقيع اتفاقية العقد من قبل الطرفين و الموافقة من البنك الممول KfW وإصدار الموافقات من السلطات المعنية.
2. يمول الاتحاد الأوروبي أقسام هذا العقد من صندوقه الاستثماري الإقليمي استجابة للأزمة السورية.
3. إئتلاف مشروع بناء المدارس بقيادة الاستشاري الرئيسي دورش انترناشونال كونسلتنتس جي ام بي اتش Dorsch International Consultants GmbH وبالأشتراك مع AHT GROUP AG ودار العمران للتخطيط والهندسة والعمارة هو الاستشاري لصاحب العمل/المشتري لأغراض طلب الشراء.
4. يجب أن تتم جميع المدفوعات بالدينار الأردني في غضون ستين (60) يومًا من تقديم المطالبة أو طلب الدفع مدعمة بكتاب أو وثيقة رسمية من المشتري تثبت أن البضائع قد تم تسليمها وأن جميع الخدمات الأخرى المتعاقد عليها قد تم تنفيذها. سيتم السماح بالدفعات الجزئية للسلع المسلمة والمركبة والمقبولة مقابل تقديم المطالبة أو طلب الدفع. (شهادة من المشتري)
5. لا يجوز إعفاء المورد من أي رسوم أو ضرائب أو رسوم أخرى مطبقة داخل وخارج دولة المشتري. يتم تسعير ضريبة المبيعات والرسوم الجمركية بشكل منفصل في جداول الكميات ويتم إدراجها بشكل منفصل في جميع طلبات الدفع وسيتم تسديدها من قبل المشتري. سيتم سداد ضريبة المبيعات والرسوم الجمركية بالمبالغ الفعلية المعتمدة المدفوعة من قبل وزارة التربية والتعليم خلال فترة 90 يومًا بعد التصديق من قبل السلطة المختصة. الضريبة المقتطعة (حيثما ينطبق ذلك):
  - المدارس الممولة من قبل (الاتحاد الأوروبي)، سيتم تعويض الضريبة المقتطعة (إن وجدت) بشهادة الدفع النهائية من قبل وزارة التعليم.
  - المدارس التي تمولها الحكومة الألمانية معفاة من الضريبة المقتطعة (WHT) بموجب قرار مجلس الوزراء - خطاب رقم (A/11/1/5134213) بتاريخ 17 سبتمبر 2023، ومع ذلك، في حالة تغيير هذا المبلغ، سيتم تعويضه من قبل وزارة التربية والتعليم مع شهادة الدفع النهائية من وزارة التعليم.
6. يتم الدفع للمورد بالمبالغ المستحقة في الحسابات المصرفية التالية:
 

أدخل تفاصيل الحساب المصرفي في وقت توقيع العقد

.....

.....

.....

.....

.....
7. أي مدفوعات متعلقة بالكفالات، إذا لزم الأمر، سيتم إرسالها على ..... [رقم الحساب الخاص الذي تقدمه وزارة التربية والتعليم] .....
8. تم إرفاق كتاب رسمي من وزارة التربية لتلتزم فيه بإعادة تعويض جميع الرسوم الجمركية وضرائب المبيعات.
9. اللغة الحاكمة لهذا العقد هي اللغة الإنجليزية.
10. القانون الحاكم هو القانون الأردني.
11. يجب على المورد، وفقًا لامتنال المشتري بالشروط والأحكام بند 12، تعويض المشتري وإبعاده وموظفيه ومسؤوليه عن الضرر ضد جميع الدعاوى القضائية أو التدابير أو الإجراءات الإدارية والمطالبات والخسائر والأضرار والتكاليف والنفقات من أي نوع، بما في ذلك أتعاب المحاماة والنفقات التي قد يتحملها المشتري نتيجة لأي انتهاك أو انتهاك مزعوم لأي براءة اختراع أو نموذج منفعة أو تصميم مسجل أو علامة تجارية أو حقوق نشر أو حقوق ملكية فكرية أخرى مسجلة أو موجودة بطريقة أخرى في تاريخ العقد بسبب:
  - (i) تسليم البضائع من قبل المورد أو استخدام السلع في البلد الذي يوجد فيه الموقع ؛ و
  - (ii) البيع في أي بلد للمنتجات التي تنتجها السلع.
12. يجب ألا يغطي هذا التعويض أي استخدام للبضائع أو أي جزء منها بخلاف الغرض المحدد بواسطة العقد والمتطلبات من المورد. يجب أن لا تتجاوز قيمة التعويض الإجمالية قيمة العقد.
13. في حالة رفع أي دعوى أو مطالبة ضد المشتري، يجب على المشتري أن يعطي المورد إشعارًا على الفور بذلك، ويجوز للمورد على نفقته الخاصة وباسم المشتري القيام بمثل هذه الإجراءات أو المطالبات وأي مفاوضات لتسوية أية إجراءات أو مطالبات.
14. إذا فشل المورد في إعطاء المشتري إشعارًا في غضون ثمانية وعشرين (28) يومًا بعد استلام هذا الإشعار بأنه ينوي اتخاذ أية إجراءات أو مطالبة من هذا القبيل فسيكون للمشتري الحرية في إجراء ذلك نيابةً عنه.
15. يجب على المشتري بناءً على طلب المورد، أن يقدم كل المساعدة المتاحة للمورد في اتخاذ مثل هذه الإجراءات أو المطالبة، ويجب أن يعوضه المورد عن جميع النفقات المنطقية التي تكبدها في القيام بذلك.
16. يجب على المورد طيلة فترة العقد ومدة التوريد إلى حين استلام اللوازم والموافقة عليها من قبل المشتري ، ان يوفر تأمينًا على المركبات والنقل العام للبضائع/اللوازم المطلوبة بحدود تعويض لا تقل عن المبالغ المنصوص عليها في البند 12 أعلاه ، لأي حدث أو سلسلة من الحوادث ناتجة عن عارض متعلق بمسؤولية المورد. هذا يتضمن مسؤولية المورد العامة / مساطر الطرف الثالث الناشئة



- من أو المتعلقة بخدمات التوريد وأي مخاطر أو أحداث أخرى منصوص عليها في الاتفاقية أو مطلوبة بقانون الدولة. يجب أن يكون تأمين نقل البضائع على الأقل 110٪ (مائة وعشرة بالمائة) من مبلغ العقد المقبول ويجب أن يغطي "جميع المخاطر" وأن يشمل مخاطر الحرب و الإضراب العام.
17. يجب على المورد تقديم وثائق الفحص المطلوبة حسب التأمينات المذكورة بموجب البند 16 وأن يقوم بتزويد المشتري أو الاستشاري عندما يطلب منه القيام بذلك.
- . يجب على المورد أن يقدم للفحص أدلة مستندية تثبت أن التأمينات المطلوبة بموجب البند 16 يتم الاحتفاظ بها بشكل صحيح عندما يطلب منه الاستشاري القيام بذلك. يجوز للمشتري، بموجب إشعار يرسله إلى المورد، إنهاء العقد، كلياً أو جزئياً، في أي وقت حسب ما يراه مناسباً. يجب أن يحدد إشعار الإنهاء أن الإنهاء هو حسب ما يراه المشتري، ومدى إنهاء أداء المورد بموجب العقد، والتاريخ الذي يصبح فيه هذا الإنهاء ساري المفعول.
18. باستثناء حالات الإهمال الجرمي أو سوء السلوك المتعمد،
- (a) لن يكون المورد مسؤولاً اتجاه المشتري ، سواء في العقد أو المسؤولية التقصيرية أو غير ذلك، عن أي خسارة أو ضرر غير مباشر أو تبعية، أو فقدان الاستخدام، أو خسارة الإنتاج، أو خسارة الأرباح أو تكاليف الفائدة بشرط أن يكون هذا الاستثناء لا ينطبق على أي التزام من المورد بدفع تعويضات للمشتري ؛ و
- (b) لا يجوز أن تتجاوز المسؤولية الإجمالية للمورد تجاه المشتري، سواء بموجب العقد أو المسؤولية التقصيرية أو غير ذلك، إجمالي سعر العقد ، شريطة ألا ينطبق هذا القيد على تكلفة إصلاح أو استبدال المعدات المعيبة، أو على أي التزام المورد بتعويض المشتري فيما يتعلق بخرق براءات الاختراع/الملكية الفكرية.
19. يجب على المشتري قبول البضائع الجاهزة للشحن ولجميع البضائع التي تم شراؤها من قبل المورد في غضون ثمانية وعشرين (28) يوماً بعد استلام المورد لإشعار إنهاء العقد وفقاً لشروط العقد وأسعاره. ولما تبقى من اللوازم، يجوز للمشتري:
- (a) إكمال أي جزء وتسليمه وفقاً لشروط وأسعار العقد؛ و/ أو
- (b) الغاء باقي اللوازم ودفع مبلغ متفق عليه من الطرفان للمورد مقابل اللوازم والخدمات المكتملة جزئياً والمواد والأجزاء التي تم شراؤها مسبقاً من قبل المورد وتمت الموافقة عليها من المشتري.
20. قبل اصدار اي قرار بشأن فسخ العقد مع المورد، يجب على الاطراف عدم الاخلال بأية مسؤولية فيما يتعلق بأي اهمال أو تقصير صادر عن أي أو كلا الطرفين.
21. على المورد وفقاً لهذه الاتفاقية ألا يقبل الرشاوى، أو الهدايا، أو المدفوعات المباشرة، أو غير المباشرة أو تقديم رشاوى من أي نوع للموظفين أو ممثلي المستشار أو المشتري أو السلطة أو المسؤولين الحكوميين أو الأحزاب السياسية لأغراض التأثير على أي عمل أو قرار أو حث هذه السلطة أو المسؤول الحكومي على استخدام نفوذه مع السلطة أو الحكومة أو أي جهاز من أجل التأثير على أي عمل أو قرار غير قانوني بموجب أي قانون معمول به، وعلى المورد أن يلتزم بتوقيع نموذج الالتزام والتعهد المرفق بالوثيقة مع ضرورة توقيعه وختمه.
22. في حالة ظهور حالة من القوة القاهرة (ظروف استثنائية)، يجب على المورد إخطار المشتري كتابياً على الفور بهذه الحالة وسببها. ما لم يوجه المشتري خلاف ذلك كتابياً، يجب أن يستمر المورد في أداء التزاماته بموجب العقد بقدر المعقول وعلى المورد إيجاد الحلول البديلة للتغلب أو التخفيف من اثر الظروف الاستثنائية/القوة القاهرة.
23. في حال وجود نزاع بين المشتري والمورد ، يجب إحالة النزاع إلى التحكيم والقضاء وفقاً لقوانين بلد المشتري.
24. تعديل الأسعار غير مسموح بها بموجب هذا العقد.
25. في غضون 14 (أربعة عشر) يوماً بعد استلام تبليغ قرار الإحالة من المشتري، يجب على المورد الفائز أن يقدم للمشتري كفالة حسن التنفيذ على شكل كفالة بنكية بمبلغ 10٪ (عشرة بالمائة) من سعر العقد بالدينار الأردني. على الكفالة أن تكون كالنموذج المرفق في هذا العقد وتبقى سارية المفعول لحين استكمال اجراءات التوريد اصوليا كما وردت في بند 3.4.
26. يجب ان تكون الكفالة البنكية غير مشروطة وصادره إما (أ) من قبل بنك حسن السمعة ومتعارف عليه في بلد المشتري، أو (ب) من قبل بنك أجنبي مقبول لدى المشتري.
27. في حال فشل المورد الفائز بالعتاء بإصدار كفالة حسن التنفيذ حسب متطلبات العقد، تعتبر هذه أسباب كافية للمشتري لإلغاء قرار إحالة العطاء ومصادرة قيمة كفالة دخول العطاء.
28. يجب إلغاء كفالة حسن التنفيذ من قبل المشتري/صاحب العمل وإعادتها إلى المورد في موعد لا يتجاوز ثمانية وعشرين (28) يوماً بعد استكمال كافة الالتزامات وحسن أداء المورد بموجب العقد.
29. يتحمل المناقص المحال عليه العطاء كلفة نشر الاعلان في الجريدة الرسمية مرة واحدة.
- إذا فشل المورد في تسليم أي أو كل البضائع بحلول تاريخ (تواريخ) التسليم أو أداء الخدمات ذات الصلة خلال الفترة المحددة في العقد، يجوز للمشتري، دون الإخلال بجميع سبل الانصاف الأخرى بموجب العقد، خصم من سعر العقد، كتعويضات مقطوعة، مبلغ يعادل النسبة المحددة في الجدول أدناه من سعر تسليم البضائع المتأخرة أو الخدمات غير المنفذة عن كل أسبوع أو جزء منه تأخير حتى التسليم الفعلي أو الأداء، بحد أقصى للخصم بالنسبة المنوية المحددة في الجدول أدناه. وبمجرد الوصول إلى الحد الأقصى، يجوز للمشتري إنهاء العقد. ولا تعفي هذه الأضرار المورد من التزامه بإكمال الخدمات، أو من أي واجبات أو التزامات أو مسؤوليات أخرى قد تكون عليه بموجب العقد.

اضرار تأخير الأعمال	0.5% في الأسبوع أو أي جزء من الأسبوع للخدمات الموجلة
أقصى قدر من أضرار التأخير	10% من سعر العقد النهائي

✍



### 3.2 Form of Contract (نموذج العقد)

## Contract Agreement for Procurement of Sports Equipment for School Construction Programme-Phase 1

THIS AGREEMENT made

the *[Insert number]* day of *[Insert: month]*, *[Insert: year]*.

BETWEEN

- (1) Ministry of Education of Suleiman Al Nabulsi St 10 Al Abdali, P.O. Box 1646, Amman 11118, Hashemite Kingdom of Jordan (hereinafter called "the Purchaser"), and
- (2) *[Insert name of the bidder, which in the case of a joint venture shall be the name of the joint venture]*, a corporation incorporated under the laws of *[Country of Supplier or incase of the JV country of both members]* and having its principal place of business at *[Address of Supplier or incase of the JV address of both members]* (hereinafter called "the Supplier").

WHEREAS the Purchaser invited bids for certain Goods and ancillary services, viz., **510929-Procurement of Sports Equipment for School Construction Programme-Phase 1** and has accepted a Bid by the Supplier for the supply and installation(Where required) of those Goods and Services in the sum of *[Contract Price in words and figures, expressed in the Contract currency(ies)]* (hereinafter called "the Contract Price").

NOW THIS AGREEMENT WITNESSETH AS FOLLOWS:

1. In this Agreement words and expressions shall have the same meanings as are respectively assigned to them in the Contract documents referred to.
2. The following documents shall be deemed to form and be read and construed as part of this Agreement. This Agreement shall prevail over all other contract documents.
  - (a) The Letter of Acceptance;
  - (b) Performance Guarantee;
  - (c) Bill of Quantities;
  - (d) Signed Declaration of Undertaking;
  - (e) The Addenda Nos. \_\_\_\_\_ (if any);
  - (f) Tender Documents, Specifications and bidding forms including price schedules;
  - (g) Supplier's bid as well as any other document listed in forming part of the contract.
3. In the event of any discrepancy or inconsistency within the Contract documents, then the documents shall prevail in the order listed above.
4. In consideration of the payments to be made by the Purchaser to the Supplier as specified in this Agreement, the Supplier hereby covenants with the Purchaser to provide the Goods and Services and to remedy defects therein in conformity in all respects with the provisions of the Contract.
5. The Purchaser hereby covenants to pay the Supplier in consideration of the provision of the Goods and Services and the remedying of defects therein, the Contract Price or such other sum as may become payable under the provisions of the Contract at the times and in the manner prescribed by the Contract.

IN WITNESS whereof the parties hereto have caused this Agreement to be executed in accordance with the laws of the Hashemite Kingdom of Jordan on the day, month and year indicated above.

For and on behalf of the Purchaser:

Signed: *[Signature]*

In the capacity of *[Title or other appropriate designation]*

In the presence of *[Identification of official witness]*

For and on behalf of the Supplier:

Signed: *[Signature of authorized representative(s) of the Supplier]*

In the capacity of *[Title or other appropriate designation]*

In the presence of *[identification of official witness]*



## Letter of Acceptance

[Use letterhead paper of the Purchaser]

[Insert date]

To: [Insert name and address of the Supplier]

Subject: **Notification of Award Contract No. [510929]**

This is to notify you that your Bid dated [Insert date] for execution of the " 510929 Procurement of Sports Equipment for School Construction Programme-Phase 1" for the Accepted Contract Amount of [Insert contract price in numbers and words including code and name of currency], as corrected and modified in accordance with the Instructions to Bidders is hereby accepted by the undersigned Purchaser.

You are requested to furnish the Performance Security within twenty-eight (28) days in accordance with the Conditions of Contract, using for that purpose the Performance Security Form included in Section X, Contract Forms, of the Bidding Documents.

Authorized Signature: \_\_\_\_\_

Name and Title of Signatory: \_\_\_\_\_

Name of Institution: \_\_\_\_\_

**Attachment: Contract Agreement<sup>7</sup>**

<sup>7</sup> If the Purchaser cannot send the contract agreement together with the letter of acceptance, it must be sent electronically to the Supplier within a reasonable period of time not exceeding ten days; for the purpose of issuing the required Performance Guarantee, the supplier must be advised of the Contract date.



### 3.3 Performance Security Form (نموذج كفالة حسن التنفيذ)

Beneficiary:

Ministry of Education  
International Tender Division for  
Procurement, MoE, Second Floor  
Al Abdali PO Box \*\*\*  
Amman \*\*\* Jordan  
Tel: (962) 6 \*\*\*\*\*  
Email: \*\*\*\*\*@moe.gov.jo

Date:

[Insert date of issue]

PERFORMANCE GUARANTEE No.:

[Insert guarantee reference number]

Guarantor:

[Insert name and address of place of issue, unless indicated in the letterhead]

We have been informed that **Name of Supplier** ..... (hereinafter called "the Applicant") has entered into Contract No....., dated.....with the Beneficiary, for the "**Procurement of Sports Equipment for School Construction Programme-Phase 1** " (hereinafter called "the Contract"). Furthermore, we understand that, according to the conditions of the Contract, a performance guarantee is required for **10%** (Ten percent) of the contract price.

Waiving all objections and defences, we, as Guarantor, hereby irrevocably and independently undertake to pay the Beneficiary, any sum or sums not exceeding in total an amount of JOD.....(in ..... words ..... **Jordanian Dinar**<sup>8</sup> upon receipt by us of the Beneficiary's first demand, supported by the Beneficiary's statement, whether in the demand itself or a separate signed document accompanying or identifying the demand, stating that the Applicant is in breach of its obligation(s) under the Contract, without the Beneficiary needing to prove or to show grounds for the demand or the sum specified therein.

In the event of any claim under this guarantee, payment shall be effected to ..... [Special account No. to be provided by MoE..... for the account of **Ministry of Education, Hashemite Kingdom of Jordan.**

This guarantee shall expire not later than .....<sup>9</sup>.

By this date we must have received any claims for payment by letter or encoded telecommunication.

It is understood that you will return this guarantee to us on expiry or after payment of the total amount to be claimed hereunder.

This guarantee is governed by the laws of the Hashemite Kingdom of Jordan.

Place, date.

Guarantor's authorized signature(s)

<sup>8</sup> This guarantee shall be issued in the contract currency only.

<sup>9</sup> the guarantee shall be valid for at least 28 days from the date of contractual contract completion and necessary approvals obtained.