



GERMAN-JORDANIAN DEVELOPMENT COOPERATION

School Construction Programme (SCP)



Report Changes Table – ESIA and ESMP Report – School No. 2 Howwara

No.	Ref. / Pg. Report	Section Name	20200921 Comments by KfW	20200928 Changes by Consultant
1.	Pg. 11 Section 3.3 Bullet point 5	Relevant National Legislative and Regulatory Framework	It is recommended to provide the links of Guide No 11 & 12 for easy reference and review by contractors	Added
2.	Pg. 34 Section 6.4 Table 6-3 Point 7	Impact Categorisation	Add the same under “Community Health and Safety” in Table 6-3 but for construction duration “spread Covid-19 amongst labors”	Added
3.	Pg. 35 Section 7 Line 19	Environmental and Social Management Plan	Could you fix “Error.! Reference source not found”	Fixed



Funded by the European Union
بتمويل من الاتحاد الأوروبي

KFW



Funded by the European Union, through the EU Regional Trust Fund
in response to the Syrian crisis, the EU Madad Fund

School Construction Programme (SCP)

FC BMZ No.: 2016 68 334 (SCP I) & 2016 68 938 (SCP II)

BMZ No.: 3020 00131

EU No.: - TF-MADAD/2018/T04.112

Environmental and Social Impact Assessment (ESIA) and Environmental and Social Management Plan (ESMP) Report

School No. 2 – Howwara Secondary Mixed School
(Irbid Governorate)

EU Component – Fast-Track



Date of issue: 28 September 2020 | FINAL

Prepared by: Joint Venture SCP lead by Dorsch International Consultants GmbH

Version	Prepared by	Reviewed by	Approved by	Date
01	Nadine Ghantous Environmental Expert	Dr. Dirk Matzke Environmental Expert	Tanja Baur Head of Division	07 May 2019
02	Nadine Ghantous Environmental Expert	Dr. Dirk Matzke Environmental Expert	Tanja Baur Head of Division	19 June 2019
03	Nadine Ghantous Environmental Expert	Dr. Dirk Matzke Environmental Expert	Tanja Baur Head of Division	09 July 2019
04	Nadine Ghantous Environmental Expert	Dr. Dirk Matzke Environmental Expert	Luis Palmeira Senior Programme Manager	04 November 2019
05	Nadine Ghantous Environmental Expert	Dr. Dirk Matzke Environmental Expert	Luis Palmeira Senior Programme Manager	11 December 2019
06	Saba' Alhamarneh Environmental Engineer	Dr. Dirk Matzke Environmental Expert	Luis Palmeira Senior Programme Manager	16 September 2020
07	Saba' Alhamarneh Environmental Engineer	Dr. Dirk Matzke Environmental Expert	Luis Palmeira Senior Programme Manager	28 September 2020

Approval on Final Version Only:

MoPWH Signature¹: _____

MoE Signature: _____

¹ MoPWH approved the ESIA-ESMP report for School No. 2 – Howwara Basic Mixed School (see Annex 4)

TABLE OF CONTENT

1. INTRODUCTION	1
1.1. PROJECT BACKGROUND	1
1.2. SITE SELECTION APPROACH	1
2. OBJECTIVES OF ESIA ASSESSMENT REPORT AND SITE SELECTION	2
2.1. OBJECTIVES OF THE ASSESSMENT REPORT	2
2.2. SELECTED PROJECT LOCATION – HOWWARA BASIC MIXED SCHOOL	2
3. LEGISLATIVE AND INSTITUTIONAL FRAMEWORK	5
3.1. KFW SUSTAINABILITY GUIDELINE	5
3.2. DONOR SAFEGUARD REQUIREMENTS AND APPLICABLE STANDARDS	6
3.2.1. <i>EU Environmental and Social Standards</i>	6
3.2.2. <i>World Bank Environmental and Social Standards</i>	6
3.2.3. <i>Core Labour Standards (CLS) of the International Labour Organization</i>	7
3.3. RELEVANT NATIONAL LEGISLATIVE AND REGULATORY FRAMEWORK	7
3.4. GAP ANALYSIS	12
4. ASSESSMENT PROCESS	13
4.1. INITIAL ENVIRONMENT EXAMINATION (IEE)	13
4.2. RESULTS OF SITE VISIT – 3 RD APRIL 2019	13
4.3. RESULTS OF SITE VISIT – 29 TH APRIL 2019	13
4.4. INITIAL STAKEHOLDER PARTICIPATION	14
5. ENVIRONMENTAL AND SOCIAL BASELINE CONDITIONS	16
5.1. PHYSICAL ENVIRONMENT	16
5.1.1. <i>Soil</i>	16
5.1.2. <i>Land Use</i>	16
5.1.3. <i>Noise and Vibrations</i>	16
5.1.4. <i>Water Resources</i>	17
5.1.5. <i>Air Quality</i>	19
5.1.6. <i>Road Access & Traffic</i>	20
5.2. SOCIO-ECONOMIC ENVIRONMENT	20
5.2.1. <i>Catchment Area</i>	20
5.2.2. <i>Access to Medical, Communal and Religious Services</i>	22
5.2.3. <i>Small Scale Business</i>	23
5.2.4. <i>Overview of Demographic Profile</i>	23
5.3. BIOLOGICAL ENVIRONMENT	23
6. IMPACT IDENTIFICATION AND ANALYSIS	24
6.1. EXPECTED ENVIRONMENT AND SOCIAL IMPACTS	24
6.2. IMPACT SIGNIFICANCE ASSESSMENT	24
6.3. PROPOSED TOPICS TO BE SCOPED OUT	25
6.4. IMPACT CATEGORISATION	25
7. ENVIRONMENTAL AND SOCIAL MANAGEMENT PLAN	35
7.1. CONTRACTORS, ENGINEERS AND EMPLOYER ROLES AND RESPONSIBILITIES	35
7.2. ENVIRONMENTAL AND SOCIAL MITIGATION DURING CONSTRUCTION & OPERATION	37
7.3. ENVIRONMENTAL AND SOCIAL MONITORING DURING CONSTRUCTION & OPERATION	47
8. STAKEHOLDER ENGAGEMENT PLAN	58
8.1. GRIEVANCE MECHANISM FOR THE CONCERNED PUBLIC	58
8.2. GRIEVANCE MECHANISM FOR WORKERS	60
8.3. MONITORING OF STAKEHOLDER ENGAGEMENT PLAN	61

LIST OF ANNEXES

ANNEX 1:	OFFICIAL LETTER OF MOENV. REGARDING EIA PROCEDURES
ANNEX 2:	INITIAL ENVIRONMENTAL EXAMINATION (IEE) PROTOCOLS
ANNEX 3:	NO OBJECTION OF SCHOOL CONSTRUCTION AT HOWWARA SITE
ANNEX 4:	MOPWH APPROVAL OF ESIA – ESMP REPORT
ANNEX 5:	PUBLIC CONSULTATION PROTOCOL

LIST OF FIGURES

Figure 2-1: Overview map locating Howwara site in Irbid Governorate	3
Figure 2-2: Location map of segmented land plots of Howwara site	4
Figure 2-3: Location map of unified land plot of Howwara site	4
Figure 2-4: Panoramic view of the Howwara site location	4
Figure 5-1: Howwara project site water transmission system in Irbid Governorate	17
Figure 5-2: Surface Water Basins in Jordan	18
Figure 5-3: Groundwater Basins in Jordan	19
Figure 5-4: Road access to School Site No. 2	20
Figure 5-5: Details of Schools located within a 1.5km radius of the School Site No.2.....	21
Figure 5-6: Catchment Area of School No. 2 Howwara Basic Mixed School ...	22
Figure 5-7: Location of closest mosque (Al Iman Mosque) to Howwara project site	22
Figure 8-1: Proposed Grievance Mechanism Procedure	60

LIST OF TABLES

Table 4-1: List of concerned stakeholders	15
Table 5-1: Population statistics of Howwara	23
Table 6-1: Classification of impacts	25
Table 6-2: Summary of environmental and socio-economic impacts during construction phase	31
Table 6-3: Summary of environmental and socio-economic impacts during operation phase.....	34
Table 7-1: Environmental and social mitigation measures during construction phase.....	44
Table 7-2: Environmental and social mitigation measures during operation phase	46
Table 7-3: Environmental and social monitoring during construction.....	54
Table 7-4: Environmental and social monitoring during operation	57

LIST OF ABBREVIATIONS

BMZ	Federal Ministry of Economic Cooperation and Development
CESMP	Contractor's Environmental and Social Management Plan
CLS	Core Labour Standards
Consultant	Dorsch International Consultants GmbH in Joint Venture with AHT Group AG and DAR AL OMRAN Planning, Architecture and Engineering
DoA	Department of Antiquities
DoE	Directorate of Education
DoS	Department of Statistics
E&S	Environment & Social
ESHS	Environmental, Social, Health and Safety
ESIA	Environmental and Social Impact Assessment
ESMP	Environmental and Social Management Plan
ESS	Environmental and Social Standards
EU	European Union
IEE	Initial Environmental Examination
(I)FC	(International) Financial Cooperation
ILO	International Labour Organization
KfW	KfW Development Bank
km	Kilometre (= 1,000 m)
LaL	Land Acquisition Law
m	Meter
MoA	Ministry of Agriculture
MoE	Ministry of Education
MoEnv	Ministry of Environment
MoH	Ministry of Health
MoL	Ministry of Labour
MoMA	Ministry of Municipal Affairs
MoPIC	Ministry of Planning and International Cooperation
MoPWH	Ministry of Public Works and Housing
MWI	Ministry of Water and Irrigation
NGO	Non-Governmental Organization
NTS	Non-technical Summary
PEA	Project Executing Agency
PIA	Project Implementing Agency
PPE	Personal Protective Equipment
SCP	School Construction Programme

SEP	Stakeholder Engagement Plan
ToR	Terms of Reference
WB	World Bank (Group)

1. INTRODUCTION

1.1. Project Background

In general, Jordan has a functional educational system, with an infrastructure that is characterized by quantitative and qualitative bottlenecks. The high number of refugees as a consequence of the Syria crisis poses additional strain on the educational system. Overcrowding and double shifts have led to worsened learning conditions and decreased educational quality, leading to political and social tensions among different population groups in Jordan. The consequences are low personal and economic development perspectives for the emerging generation. The need for additional schooling capacities has been outlined by the Jordanian Government within the Jordan Response Plan (JRP) to the Syria crisis.

The main target group of the programme are Jordanian and Syrian children living in communities with a particularly high share of vulnerable Jordanian children as well as of Syrian refugees.

Therefore, the Schools Construction Program (SCP) is to improve learning conditions in the field of basic education in the target areas depending on the site selection process through the provision and adequate utilization of additional school infrastructure and the corresponding equipment.

In order to support the Jordanian government in addressing such challenges, the Government of Germany, represented through BMZ, and the European Union have planned to provide funds for the construction, extension and equipment of public basic schools in Jordan, including associated consulting services, and the construction and the equipping of ten new schools in Jordan and the financing of related accompanying measures, respectively. Therefore, the SCP will be implemented by the KfW Development Bank and will cover two main components:

Component 1: FC Component funded by the German Government through KfW which comprises the projects “School Construction Programme I (BMZ No. 2016 68 334)” and “School Construction Programme II (BMZ No. 2016 68 938)”

Component 2: EU Component funded by the European Union (EU) through KfW, which encompasses the construction of 10 new schools and Complementary Measures

The ultimate beneficiary will be the Hashemite Kingdom of Jordan, represented by the Ministry of Planning and International Cooperation (MoPIC), which will channel the funds to MoPWH (construction works) and MoE (furniture and equipment) respectively. Hence, MoPIC has signed the Financing Agreement with KfW. Both MoE and MoPWH have signed the Separate Agreement to the Financing Agreement. MoPWH shall act as Project Executing Agency (PEA), while MoE shall be the Project Implementing Agency (PIA).

1.2. Site Selection Approach

Under the framework of the SCP, the MoE (PIA) shall provide the MoPWH (PEA), with a Master List of 50 recommended sites to be considered as potential for new school projects or school expansion projects. The Consultant shall carry out a site selection process to the existing list to determine a shortlist of 10 new schools to be constructed under the EU Component and up to 13 new/expanded schools under the FC Component.

In the Site Selection Report (SSR) – Volume 1, the Consultant, proposed fast tracking some sites in order to ease the pressure on the Jordanian education system and mobilize the funds of the EU Component given the limited timeframe. As a result, four (4) initially suitable site locations have been identified under the Fast Track configuration.

This report follows the approved structure assessment and addresses Howwara Basic Mixed School (School No. 2 of the Master List), allocated under the EU Component.

2. OBJECTIVES OF ESIA ASSESSMENT REPORT AND SITE SELECTION

2.1. Objectives of the Assessment Report

The implementation of the SCP may have the potential to cause environmental and/or social impacts that shall be addressed in accordance to relevant Jordanian legislations as well as the requirements of the KfW Development Bank Sustainability Guidelines of 2016, the EU Environmental and Social (E&S) Standards, the World Bank Environmental and Social Standards and those of the International Labour Organisation (ILO). Chapter 3 provides more details on the applicable legislative framework for the SCP.

The environmental clearances and permits are governed by the Ministry of Environment (MoEnv), under the stipulations of the Environmental Impact Assessment No. (37) of 2005. Based on consultations with the Licensing Department of the (MoEnv) in May 2019, it has been officially confirmed that the scope of this project does not require the involvement of MoEnv (response letter of MoEnv to MoPWH dated 29 May 2019 saved as Annex 1).

This report covers the environmental and social assessment for Howwara site located in Irbid Governorate, one (out of four) of the designated Fast Track locations. The objective of the report is to provide an initial Environmental and Social Assessment in order to identify important environmental and socio-economic issues arising from the proposed works, especially prior and during construction of the proposed school and to prepare a corresponding Environmental & Social Management Plan (ESMP).

In accordance to the above, the following structure has been followed in this ESIA Assessment Report:

- Chapter 1: provides a general overview of the Program, its components, expected service and beneficiaries
- Chapter 2: this chapter provides a description objective of this ESIA Assessment Report and its structure
- Chapter 3: provides a description of the applicable local and international Legislative and Institutional Framework
- Chapter 4: provides a description of the Assessment process implemented for this project site
- Chapter 5 provides a description of the Environmental and Social Baseline Conditions
- Chapter 6: presents the identification of impacts and its related analysis
- Chapter 7: presents the corresponding Environmental and Social Management Plan (ESMP) as well as the related Monitoring Plan
- Chapter 8: Stakeholder Engagement Plan

2.2. Selected Project Location – Howwara Basic Mixed School

The proposed Howwara site is located in Qasabet Irbid belonging to Irbid Governorate as shown in Figure 2-1, which is intended to cater for the overcrowded schools within the catchment area as well as accommodate future demand. The new proposed Howwara Basic Mixed School shall accommodate a total range of students from 662 (including 50 students at KG levels) up to 730 (including 50 students at KG level). Further details are provided in Section 5.2.1.

Initially, the site allocated for the construction of the school was made up of five (5) adjacent land plots: No. 210, 211, 212, 213 and 322 in Basin no. 27 totalling an area of 9,017m² as shown in Figure 2-2. These land plots are under the ownership of the MoE. Based on recent updates on the online database of the Department of Land and Survey (DLS), the project site location is now unified as one land plot with a distinct land plot number 538, as shown in Figure 2-3.

While the plot is accessible through mainly unpaved-yet roads, there are no dangerous highways around it. The site is located in a residential area surrounded by many vacant land plots that are yet to be developed. All supply utilities such as water, sewerage and electricity are available.

The closest mosque, Al Iman Mosque, is some 750m away from the proposed site. Medical and communal service facilities are located in the town. Embedded in a residential area no industrial activities are found. Also, typical small scale business activities are almost absent.

The site has been visited and inspected and is found to comply with most of the major physical/technical criteria. It is a fresh uniform piece of land at the outskirts of a bigger conglomeration which is utilized as fertile farm land covered partly by olive trees (plots 210-213) and wheat (plot 322) and with almost unnoticeable slope.

The vacant piece of land which has an area of around 4,400m² (plot 322) should be enough to build the intended school. If, during the design phase, additional land area is required, the neighbouring land plots of (210 – 213) planted with olive trees can be used. Cultivated olive trees are in good condition and already used for olive production. If needed, the trees can be safely removed and replanted elsewhere. Further baseline analysis of the site is presented in Chapter 5.

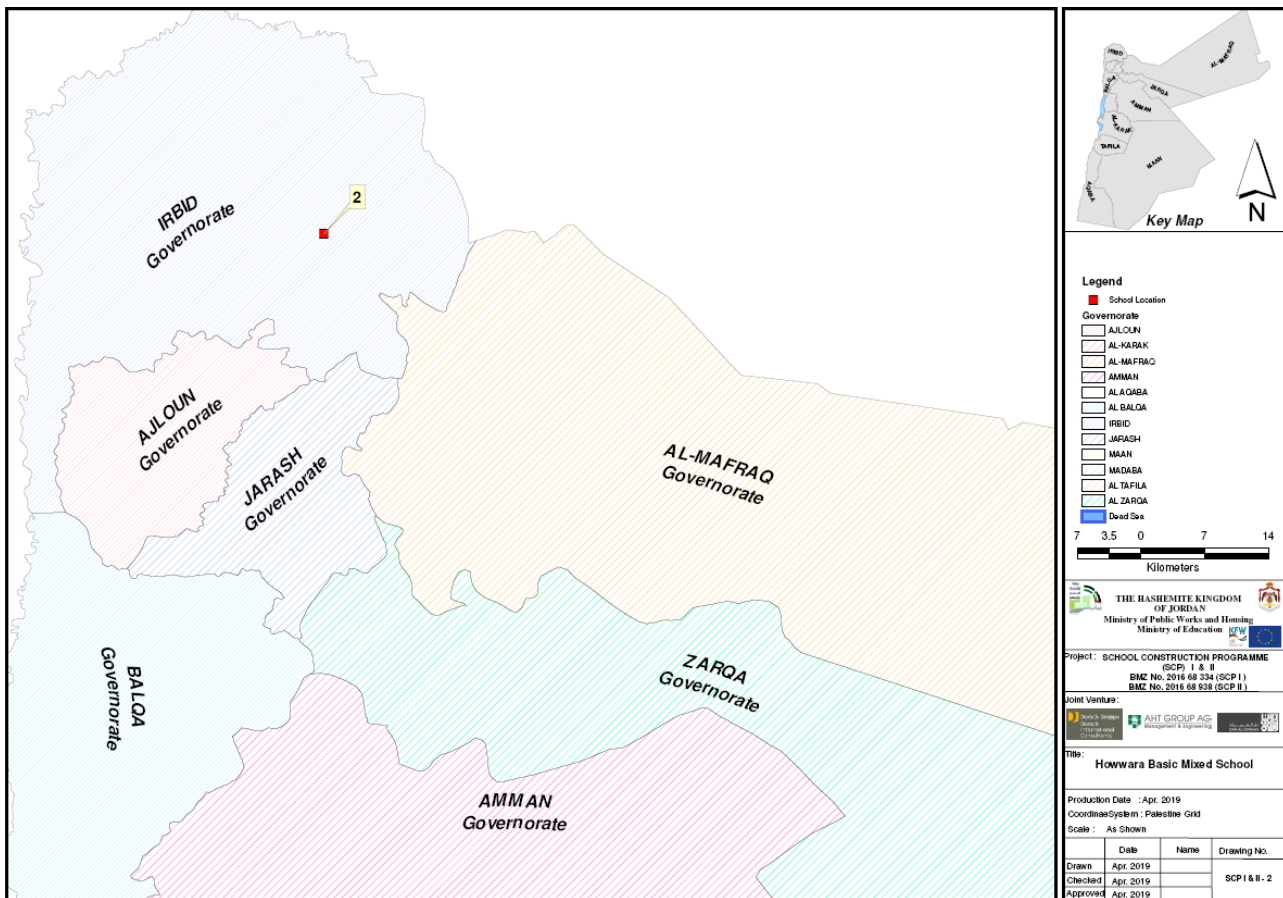

Figure 2-1: Overview map locating Howwara site in Irbid Governorate

Source: Consultant, School Selection Report Vol 1, May 2019



Figure 2-2: Location map of segmented land plots of Howwara site

Source: Consultant, School Selection Report Vol. 1, May 2019



Figure 2-3: Location map of unified land plot of Howwara site

Source: Department of Land and Survey, DLS, 2019



Figure 2-4: Panoramic view of the Howwara site location

Source: Consultant, site visit, April 2019

3. LEGISLATIVE AND INSTITUTIONAL FRAMEWORK

This section addresses the legislative and institutional framework relating to ESIA development, specifically relevant to the SCP and the environmental and social impact assessment associated with this type of projects. For this project the ESIA (here ESIA Assessment Report) has been prepared under specific consideration of the:

- Sustainability Guideline of KfW Development Bank,
- EU Environmental and Social Standards
- World Bank Environmental and Social Standards, and
- Core labour standards of the International Labour Organisation (ILO).

The national framework considers environmental laws and regulations of the Government of the Hashemite Kingdom of Jordan, in particular, the Environmental Protection Law No.6 last amended in the year 2017.

Based on consultations with the Licensing Department of the (MoEnv) in May 2019, it has been officially confirmed that the scope of this project does not require the involvement of MoEnv (response letter of MoEnv to MoPWH dated 29 May 2019 saved as Annex 1).

3.1. KfW Sustainability Guideline

With the aim of sustainability and avoiding adverse environmental, social and climate impacts and risks, KfW Development Bank policy requires consideration of corresponding sustainability principles in Financial Cooperation (FC) measures that are financed.

In this context, the appropriate consideration of environmental and social requirements in proposed projects prior to the start of the services is crucial. The guiding document is the KfW Sustainability Guideline last amended in the year 2016. In accordance with the KfW Sustainability Guideline (Chapter 4.3.2.3 to 4.3.2.5) FC measures are categorised as A to C depending on their potential of environmental and social impacts or risks.

Moreover, in the light of the COVID-19 outbreak, KfW Development Bank issued an Info-Sheet in April 2020 on Preventing and Managing related Environmental, Social, Health and Safety (ESHS) risks as a guidance document aiming to minimize the risks caused by the virus in the development finance context especially with regards to social topics and occupational health and safety. It is addressed to project executing agencies, implementation consultants, EPC contractors, project's developer, private equity funds and financial institutions and includes namely recommendations on managing risks, communications with both employees and stakeholders, retrenchment, dealing with worker camps, etc.

With regard to the School Construction Programme in order to comply with the provisions of the KfW Sustainability Guideline under the legislative framework described earlier, the Consultant has undertaken a two-step procedure. The first step is the preparation of an Initial Environmental Examination during field trips to the concerned site followed by the more detailed development of an ESIA Assessment Report. Reference is made to Chapter 4.

3.2. Donor Safeguard Requirements and Applicable Standards

3.2.1. EU Environmental and Social Standards

The Environmental legislations of the EU are considered to be greatly intertwined with various international and national environmental policies that address vital issues across the environmental and social spectrum. These extensive policies aim to protect natural habitats, keeping the air and water clean, ensure sound waste disposal, as well as promoting a sustainable economy.

Given that the KfW Sustainability Guidelines (2016) refer to the EU Environmental and Social Standards, the EU Environmental Impact Assessment Directive 2011/92/EU and its latest amendments 2014/52/EU is the main governing legislation which can govern the preparation of this ESIA Assessment Report.

In accordance to Annexes I and II, the activities planned under the SCP do not fall under either classification, therefore as mentioned in the Directive, Member States may determine whether the project shall be made subject to an assessment, based on either a case-by-case examination or thresholds or criteria set out by Member States. As described previously, the Jordanian legislations do not require the preparation of the EIA for this project.

Following an equal approach as the KfW Sustainability Guideline this ESIA Assessment Report is complying with the stipulations of the EIA Directives 2011/92/EU & 2014/52/EU, here Articles 5 – 10.

3.2.2. World Bank Environmental and Social Standards

Under the World Bank's Environmental and Social Framework issued in 2017, ten (10) Environmental and Social Standards have been identified to outline the requirements for the "Borrower" relating to the identification and assessment of environmental and social risks and impacts associated with projects supported by the Bank through Investment Project Financing. Such standards will support the "Borrower" in achieving good international practices within the scope of environmental and social sustainability; fulfil national and international E&S obligations; promote non-discrimination, transparency, participation, accountability and governance, and enhance sustainable development outcomes of projects through ongoing stakeholder engagement.

In general, there are ten (10) ESS; subject to consideration or exclusion (scope out) to the SCP:

- ESS 1: Assessment and Management of Environmental and Social Risks and Impacts
- ESS 2: Labour and Working Conditions
- ESS 3: Resource Efficiency and Pollution Prevention and Management
- ESS 4: Community Health and Safety
- ESS 5: Land Acquisition, Restrictions on Land Use and Involuntary Resettlement
- ESS 6: Biodiversity Conservation and Sustainable Management of Living Natural Resources
- ESS 7: Indigenous Peoples/Sub-Saharan African Historically Underserved Traditional Local Communities
- ESS 8: Cultural Heritage
- ESS 9: Financial Intermediaries
- ESS 10: Stakeholder Engagement and Information Disclosure

Given the initial analysis and applicability of the above mentioned standards, ESS 7 and ESS 9 are not applicable based on the following justifications.

ESS 7 "*Indigenous Peoples/Sub-Saharan African Historically Underserved Traditional Local Communities*" is not applicable, as there are no such groups or communities within the project site area nor are such groups affected by the Project.

ESS 9 "Financial Intermediaries" is not applicable, as there are no FIs involved in this Project.

Environmental and social issues considered as not relevant to the SCP are assessed and scoped out during the impact identification and analysis process (Chapter 6).

General Environmental Health and Safety Guidelines

The General EHS Guidelines developed by the International Finance Corporation (IFC), cover a wide range of technical references that can be applied to general and industry-specific actions that resonate with Good international Industry Practices (GIIP). These Guidelines can be applicable to this program, along with the mentioned legislations outlined in this chapter. Specifically, the following EHS guidelines can be considered:

- General EHS Guideline (1): Environmental
- General EHS Guideline (2): Occupational Health and Safety
- General EHS Guideline (3): Community Health and Safety
- General EHS Guidelines (4): Construction and Decommissioning

3.2.3. Core Labour Standards (CLS) of the International Labour Organization

The International Labour Organization (ILO) is a tripartite organization consisting of trade unions, governments and companies, and is part of the United Nations system. In 1998, the ILO produced the Declaration on Fundamental Principles and Rights at Work. In the Declaration, ILO member states agreed that they should all respect, promote, and realize Core Labour Standards (whether or not they have ratified them).

The core labour standards consist of four standards, laid out in eight conventions:

- Freedom of association and the effective recognition of the right to collective bargaining (Convention No. 87 & No. 98).
- The elimination of all forms of forced and compulsory labour (Convention No. 29 & No. 105).
- The effective abolition of child labour (Convention No. 138 & No. 182).
- The elimination of discrimination in respect of employment and occupation (Convention No. 100 & No. 111).

Today all International Financing Institutions including KfW have fully adopted CLS in their activities. In contrast Jordan has not ratified ILO Convention No. 87 (Freedom of Association and Protection of the Right to Organize Convention), one of the eight fundamental conventions.

Responding adequately to this situation the Consultant will assess whether the project has to establish any provisions in order to bridge any gaps resulting from non- ratification of the convention.

3.3. Relevant National Legislative and Regulatory Framework

This section outlines the Jordanian Legislative and Regulatory framework relevant to this project, as well as the guidelines issued by the government with regards to COVID-19. The legislations of various authorities must be taken into consideration to ensure an all-inclusive understanding of the specific requirements and obligations.

The legislations and guidelines listed below have been tailored to apply the anticipated activities of this project to guarantee the protection of social, health and environmental aspects; where specific stipulations and clauses may apply in reference to the scope of this Programme.

- **Laws:**
 - Environmental Protection Law No. 6 of 2017

This Law aims at highlighting the responsibilities of the Ministry of Environment (MoEnv) as the responsible entity for ensuring the protection of the environment including aspects such as Air, Noise, Biodiversity, Community Health and Safety, and other receptors from the impacts of various projects. The MoEnv is also responsible for issuing licenses and approving ESIA studies prior to the establishment of facilities and/or projects.

- Municipalities Law No. 41 of 2015

This Law stipulates the responsibilities of Municipalities and relevant councils towards developing and implementing programs that ensure sustainable development throughout the Kingdom. Given the coordination between various entities, the main municipality services include solid waste management, manage water supply, preventing pollution, monitoring sanitation systems as well as public transport

- Labour Law No. 8 of 1966 and its amendments

The Labour Law was issued to guarantee the rights employers, employees and the government in terms of employment conditions, working hours, wages, health and safety requirements and all related Labour management issues. The Ministry of Labour (MoL) also issued various regulations and instructions that can be considered relevant under the Labour Law.

- Agricultural Law No. 13 of 2015

This Law aims to outline the obligations of the Ministry of Agriculture and its obligations towards combating desertification and conserving biodiversity in the Kingdom. The Ministry also issued various regulations that can be considered relevant under this Law.

- Water Authority Law No. 18 of 1988 and its amendments

This Law, issued by the Ministry of Water and Irrigation (MWI), and its amendments includes the responsibility the Ministry undertakes to protect all water resources of the country, by considering that all surface and groundwater sources are state-owned, and must be handled according to the stipulations of this Law and other relevant regulations, standards and instructions.

- Public Health Law No. 47 of 2008

The Law, issued by the Ministry of Health (MoH), prohibits health nuisance and identifies it as disposing or emptying the content of septic tanks in un-allocated places, medical wastes, liquid, solid or gaseous wastes, or nuisances that affect public health or cause a disturbance of public comfort.

- Antiquities Law No. 21 of 1988 and its amendments (No. 23 of 2004)

This Law issued by the Department of Antiquities (DoA) highlights the responsibilities of the Department including the obligation of issuing excavation permits for any site in the Kingdom; whereas, the Department has the sole right to carry out surveying or excavating of antiquities.

- Civil Defence Law No. 18 of 1999

This law states the responsibility of the Civil Defence Department (CDD) for its protection and ensuring the protection of citizens and the tasks to be performed in emergency cases. The CDD is a member of the National Jordanian Building Council, to hold the responsibility of approving various Jordanian national building codes.

- Jordanian National Building Law No. 7 of 1993 and its amendments (No. 24 of 2018)

This Law stipulates the responsibilities of the National Jordanian Building Council to ensure the compliance of all construction projects to National Building Codes that aim to ensure technical construction safety measures (i.e. firefighting systems code, warning systems code, fire prevention code and shelters code).

- Traffic Law No. 49 of 2008

This Law stipulates the responsibilities of the Traffic Department and the Public Security Department towards ensuring safe transportation within the Kingdom, including speed limits, licensing processes, vehicle conditions and its emissions of pollutants.

- Planning Cities, Towns, Villages and Building Law No. 79 of 1966 and its amendments

This Law, issued by the Ministry of Municipal Affairs (MoMA), applies to all types of land uses and buildings and on any commercial establishments, when such lands and buildings fall within the current organized boundaries or are anticipated to fall within the boundaries.

- Acquisition Law No. 12 of the year 1987

The Law outlines the processes conducted for cases of land acquisition including advertising requirements, determination of fair compensations, and negotiation process with land owners, grievance and dispute procedures. It should be made clear that no land can be acquired unless it is for public benefit and that there is fair and transparent compensation procedure,

- **Regulations:**

- Environmental Impact Assessment Regulation No. 37 of 2005

This regulation outlines the requirements for conducting a comprehensive or preliminary Environmental Impact Study, depending on the type of projects being considered. The MoEnv is responsible for issuing such decisions, under their licensing department.

- Land Use Planning Regulation No. 6 of 2007

This regulation applies to areas that are not considered within the land use planning boundaries, outlined by the MoMA, which are categorised based on several criteria outlined in the official Land Use Map approved by the Council of Ministers.

- Regulation of Planning Cities, Towns, Villages and Building No. 136 of 2016 and its amendments (No. 13 of 2019)

This regulation applies to land plots, buildings, and construction projects on regulated areas in the Kingdom in addition to any legal person/entity, except for regulated areas having their own specific regulations. Specifically, this regulation allows the construction of schools in residential areas.

- Soil Protection Regulation No. 25 for 2005

The MoEnv in cooperation with any other competent entity shall set the required instructions for the protection of Soil from harmful effects of industrial dust, solid waste and solid and liquid industrial waste

The MoEnv and MoA and other competent entity will monitor the source of soil pollution and control them.

- Solid Waste Management Regulation No. 27 of 2005

This MoEnv highlights the duties and responsibilities of entities towards sound solid waste management practices including qualified workforce, equipment and machines for the management of the solid waste, in addition to monitoring the collection of such wastes.

- Management, Transportation & Handling of Harmful & Hazardous Substances Regulation No. 24 of 2005

This regulation outlines the tasks that an entity must comply with when dealing with harmful and hazardous substances

- Groundwater Control Regulation No. 85 of 2002 and its amendments

This regulation mainly highlights the responsibility of the owner/occupier/contractor of a certain project site to inform the Authorities for any case of groundwater resurfacing during construction work.

- Regulation for Categorizing Wild Birds and Animals Banned from Hunting No. 43 of 2008

This regulation lists the species that should not be hunted at any circumstances.

- Air Protection Regulation No. 28 of 2005

This regulation outlines the obligations that facilities must comply with to guarantee that there are no emissions or leakages of air pollutants at a level that exceeds the maximum allowable limit according to technical standards.

- Nuisance Prevention Regulation No. 68 of 2016

This regulation describes the mandates that must be implemented by any facility to prevent any public health nuisances resulting from improper management and disposal of waste streams.

- Regulation of Protection and Safety from Industrial tools and Machines and Work Sites No. 43 of 1998 and its amendments

This regulation describes the precautionary measures that must be undertaken to ensure safety in the work environment depending on the scope of work, by considering mechanical and electrical risks.

- Formation of Committees and Supervisors of Occupational Health and Safety Regulation No. 7 of 1998

This regulation outlines the requirements for the formation of committees within an establishment of a workforce exceeding 50 employees. Such committees are responsible for ensuring suitable occupational health and safety precautions are implemented, in addition to any procedures relevant to accidents and injuries.

- Regulation for Preventive and Curative Health Care for Workers in Establishments No. 4 of 1998 and its amendments

This regulation stipulates the requirement of ensuring the employee's good health and fitness throughout the employment.

- Regulation for the Fees of Work Permits for Non – Jordanians No. 36 of 1997 and its amendments

This regulation outlines the responsibilities and fees for issuing work permits for non-Jordanians depending on the industry and duration of stay.

- Regulation for Obligatory Employment of Jordanian Workforce from Surrounding Communities in Development Projects No. (131) for the year 2016

Indicates the required number whereby Jordanian technicians, workers and recent graduates must be appointed based on varying financial values of the specific tender. The regulation dictates that contractors, engineering offices, foreign companies, executing contractors must implement the provisions of this regulation for all projects beginning from the official effective date of the regulation.

- Regulation of Buildings and Planning of Cities and Villages No. 136 of 2016 and its amendments (No. 13 of 2019)

This regulation outlines the provisions of construction projects in cities and villages throughout the Kingdom. Whereby a Higher Regulatory Council is responsible for organizing and approving any residential, governmental, or investment project based on the stipulations of this regulation.

- **Instructions:**

- Instruction for Management and Handling of Consumed Oils for 2003

This instruction outlines the prohibited disposal method of consumed oils, and outlines the conditions related to the health and safety of individuals working with such oils; indicating the PPEs should be provided.

- Instruction for Hazardous Waste Management for 2003

The Instruction, developed by the MoEnv, lists general procedures to be carried out by the producer of hazardous wastes, procedures related to the gathering and storage of hazardous waste, emergency procedures plan, record-keeping and reporting, and general precautionary measures to be taken for packing hazardous waste.

- Instruction for Reduction and Prevention of Noise for 2003

This instruction outlines the minimum noise levels allowed in residential areas of villages, in addition to prohibiting construction activities between 8:00pm till 6:00am; exceptions are made for after attaining an approval by MoEnv.

- Instructions for Allowable Speed Limits for 2002

The Instruction states allowable speed limits for vehicles with reference to their weight and the type of road.

- Instructions for the Protection of Workers against Risks of the Work Environment

This instruction provides the requirement activities that must be implemented in the work site to ensure the protection of the workforce, including required PPEs, proper resting areas, acceptable noise level limits at the workplace, in addition to the requirement of performing hearing tests for employees.

- **Standards:**

- Ambient Air Quality Standard (JS 1140 – 2006)

This Jordanian standard provides technical requirements and allowable limits for air pollutants in terms of ambient air quality.

- General Precautionary Requirements for Storage of Hazardous Materials (JS 431 – 1985)

This Standard describes the general requirements to be abided by for the proper storage and handling of hazardous substances, in addition to prohibiting unauthorized entry to such storage facilities.

- **Guidelines**

In April 2020, with reference to the COVID-19 pandemic, the Government of Jordan issued a comprehensive guide covering the work procedures related to health and safety to reduce the spread of the Corona virus. This guide includes the general health and safety practices and standard operating procedures before and during work for the different sectors. On a more specific note, the Ministry of Labour issued a separate and detailed guide for working procedures applicable to construction sites covering health and safety prevention measures to reduce the Corona Virus outbreak (Guide No.12)². This guide includes general practices in the work place, provision of health and safety protection equipment, transportation of good and transportation. The latter is addressed in another specific guide covering the safety precautions and actions to reduce and control the Corona virus outbreak in the transportation sector (Guide No.11)³.

² Ministry of Labour, "Guide 12: Working procedures for health and safety prevention measures to reduce Coronavirus outbreak in Construction sites", April 2020

[http://www.mol.gov.jo/ebv4.0/root_storage/ar/eb_list_page/%D8%AF%D9%84%D9%8A%D9%84_12_-_D8%A7%D8%AC%D8%B1%D8%A7%D8%A1%D8%A7%D8%AA_%D8%A7%D9%84%D8%B9%D9%85%D9%84_%D9%84%D8%AA%D8%AF%D8%A7%D8%A8%D9%8A%D8%B1_%D8%A7%D9%84%D8%B3%D9%84%D8%A7%D9%85%D8%A9_%D9%88%D8%A7%D9%84%D9%88%D9%82%D8%A7%D9%8A%D8%A9_%D8%A7%D9%84%D8%B5%D8%AD%D9%8A%D8%A9_%D9%84%D9%84%D8%AD%D8%AF_%D9%85%D9%86_%D8%A7%D9%86%D8%AA%D8%B4%D8%A7%D8%B1_%D9%81%D8%A7%D9%8A%D8%B1%D9%88%D8%B3_%D8%A7%D9%84%D9%83%D9%88%D8%B1%D9%88%D9%86%D8%A7_\(%D8%A7%D9%84%D9%85%D8%B4%D8%A7%D8%B1%D9%8A%D8%B9_%D8%A7%D9%84%D8%A7%D9%86%D8%B4%D8%A7%D8%A6%D9%8A%D8%A9_.pdf](http://www.mol.gov.jo/ebv4.0/root_storage/ar/eb_list_page/%D8%AF%D9%84%D9%8A%D9%84_12_-_D8%A7%D8%AC%D8%B1%D8%A7%D8%A1%D8%A7%D8%AA_%D8%A7%D9%84%D8%B9%D9%85%D9%84_%D9%84%D8%AA%D8%AF%D8%A7%D8%A8%D9%8A%D8%B1_%D8%A7%D9%84%D8%B3%D9%84%D8%A7%D9%85%D8%A9_%D9%88%D8%A7%D9%84%D9%88%D9%82%D8%A7%D9%8A%D8%A9_%D8%A7%D9%84%D8%B5%D8%AD%D9%8A%D8%A9_%D9%84%D9%84%D8%AD%D8%AF_%D9%85%D9%86_%D8%A7%D9%86%D8%AA%D8%B4%D8%A7%D8%B1_%D9%81%D8%A7%D9%8A%D8%B1%D9%88%D8%B3_%D8%A7%D9%84%D9%83%D9%88%D8%B1%D9%88%D9%86%D8%A7_(%D8%A7%D9%84%D9%85%D8%B4%D8%A7%D8%B1%D9%8A%D8%B9_%D8%A7%D9%84%D8%A7%D9%86%D8%B4%D8%A7%D8%A6%D9%8A%D8%A9_.pdf)

³ Ministry of Labour, "Guide 11: Working procedures for health and safety prevention measures to reduce Coronavirus outbreak in the Transportation sector", April 2020

[http://www.mol.gov.jo/ebv4.0/root_storage/ar/eb_list_page/%D8%AF%D9%84%D9%8A%D9%84_11_-_D8%A7%D8%AC%D8%B1%D8%A7%D8%A1%D8%A7%D8%AA_%D8%A7%D9%84%D8%B9%D9%85%D9%84_%D9%84%D8%AA%D8%AF%D8%A7%D8%A8%D9%8A%D8%B1_%D8%A7%D9%84%D8%B3%D9%84%D8%A7%D9%85%D8%A9_%D9%88%D8%A7%D9%84%D9%88%D9%82%D8%A7%D9%8A%D8%A9_%D8%A7%D9%84%D8%B5%D8%AD%D9%8A%D8%A9_%D9%84%D9%84%D8%AD%D8%AF_%D9%85%D9%86_%D8%A7%D9%86%D8%AA%D8%B4%D8%A7%D8%B1_%D9%81%D8%A7%D9%8A%D8%B1%D9%88%D8%B3_%D8%A7%D9%84%D9%83%D9%88%D8%B1%D9%88%D9%86%D8%A7_\(%D9%88%D8%B3%D8%A7%D8%A6%D8%B7_%D8%A7%D9%84%D9%86%D9%82%D9%84_.pdf](http://www.mol.gov.jo/ebv4.0/root_storage/ar/eb_list_page/%D8%AF%D9%84%D9%8A%D9%84_11_-_D8%A7%D8%AC%D8%B1%D8%A7%D8%A1%D8%A7%D8%AA_%D8%A7%D9%84%D8%B9%D9%85%D9%84_%D9%84%D8%AA%D8%AF%D8%A7%D8%A8%D9%8A%D8%B1_%D8%A7%D9%84%D8%B3%D9%84%D8%A7%D9%85%D8%A9_%D9%88%D8%A7%D9%84%D9%88%D9%82%D8%A7%D9%8A%D8%A9_%D8%A7%D9%84%D8%B5%D8%AD%D9%8A%D8%A9_%D9%84%D9%84%D8%AD%D8%AF_%D9%85%D9%86_%D8%A7%D9%86%D8%AA%D8%B4%D8%A7%D8%B1_%D9%81%D8%A7%D9%8A%D8%B1%D9%88%D8%B3_%D8%A7%D9%84%D9%83%D9%88%D8%B1%D9%88%D9%86%D8%A7_(%D9%88%D8%B3%D8%A7%D8%A6%D8%B7_%D8%A7%D9%84%D9%86%D9%82%D9%84_.pdf)

3.4. Gap Analysis

In this previous chapters a comprehensive analysis of the legislative framework including the KfW Sustainability Guideline, donor safeguard requirements of the EU, World Bank and CLS, and also the relevant national provisions has been undertaken.

In this context, potential gaps among the Jordanian EIA requirements versus KfW sustainability requirements and ILO Convention No. 87 (Freedom of Association and Protection of the Right to Organize Convention) have been identified.

Considering that the ESIA can be condensed to mainly construction related issues, mitigating eventual gaps is the site engineer's obligation. Therefore, a further detailed gap analysis is considered as not required.

The identified gap with reference to ILO Convention No. 87 is addressed in Chapter 7 Environmental and Social Management Plan (Table 7-3 Environmental and social monitoring during construction).

4. ASSESSMENT PROCESS

In order to comply with the provisions of the KfW Sustainability Guideline and other international best practices and requirements under the legislative framework described in the preceding chapter, the Consultant has undertaken a two-step procedure. The first step is the preparation of an Initial Environmental Examination (IEE) based on site visits of qualified expert teams ('technical' team and 'E&S team') followed by the more detailed development of an impact identification and analysis (Chapter 6)

4.1. Initial Environment Examination (IEE)

The Consultant proposed to develop an Initial Environmental Examination (IEE) as a tool to initially review reasonably foreseeable impacts of a proposed activity to determine potential impacts. For the SCP an IEE template has been developed allowing a quick examination during site visits. Following the findings and outcomes of the initial site visits the IEE is forming the basis for the more detailed impact identification and analysis.

Usually, the identification and assessment of project impacts is based on the collection of qualitative and quantitative data describing the physical, socio-economic and biological environment, referred to as Environmental & Social Baseline Conditions (see Chapter 5). Given the fact that such data are difficult to acquire or even not available, here the IEE is providing a central function, even when collected data are subjective as based on visual observations and not considering any seasonal variation throughout the year.

For the proposed Howwara site two site visits applying IEE form have been executed. Key findings are summarised hereafter. The filled in IEE form is attached as Annex 2.

4.2. Results of Site Visit – 3rd April 2019

The project team has conducted a site visit on the 3rd of April 2019, and has taken note of the following main observations:

- Basic Mixed School. In a circumference of 3km there are no schools. Land is flat and no obvious problems in it. The closest schools are (all 3 of which are in bad shape and have already been expanded more than once, and 2 of them are double shift schools):
 - Howwara Basic Girls School
 - Al Khansa School for Girls
 - Howwara Mixed Basic School
- Is there an issue with land ownership and/or unification? – The proposed site is composed of 5 plots owned by MoE.
- The site is a fresh piece of land at the outskirts of a bigger conglomeration which is utilized as fertile farm land covered partly by Olive trees and wheat with an almost unnoticeable slope. The land is big enough when utilizing the wheat planted area only for the school construction. The site is located in a residential area with large areas of empty lands that are yet to be developed.

Conclusion: The land is first choice serving as Fast Track location. Reference should be made to Section 5.2.1 for updated information regarding the existing schools within the catchment area of the site.

4.3. Results of Site Visit – 29th April 2019

The E&S team has conducted a site visit on the 29th of April 2019, and has taken note of the following main observations

- In terms of E&S relevant factors (physical, socio-economic, biological) the visual site inspection has shown no or insignificant conflict potential.
- Even when sparsely populated, potential negative impacts to nearby residents during the construction phase of the school can be effectively mitigated.

- In case the currently wheat cultivated plot is not sufficient for the school construction parts of the neighbouring plot cultivated with olive trees can be made available. In this case the concerned olive trees have to be safely removed and re-planted on another suitable site. According to the representative of the Directorate of Education such technology is available.

Conclusion: The high potential serving a Fast Track location can be confirmed.

4.4. Initial Stakeholder Participation

Note: A generic Stakeholder Engagement Plan (SEP) has been prepared and is added as Chapter 8.

Both, Jordan legislation and regulations, but also the KfW Sustainability Guideline state clearly that public and stakeholder engagement is mandatory to give the opportunity to the public, stakeholders and surrounding community to express their opinion in the project and gain knowledge about the project. This may lead also to alter, modify the project design, location, etc. to consider the community needs and concerns.

During IEE site visits (one by 'technical' team, on by E&S team, see Chapter 4.1) representatives of concerned authorities have joined the project teams. These site visits have already provided important information about the perceptions of concerned stakeholders (Table 4-1).

To make sure that all concerned parties are involved a public consultation process a meeting will be organised by the Consultant. The outcomes and findings of the public consultation meeting will be integrated in the Environmental & Social Management Plan; the meeting protocol added as Annex to the final version of this ESIA Assessment report.

As an initial step towards preparing a Stakeholder Engagement Plan (SEP), the Consultant has analysed the relevant stakeholders to the project, who are considered to be affected or affect the project activities. The SEP shall be implemented during construction and operation phase of the project, where the Contractor and Operator are responsible for ensuring its proper implementation. Moreover, a Grievance Mechanism shall be put in place to allow the below mentioned stakeholders in communicating their concerns regarding any project activity.

Group of Stakeholders	Stakeholders	Level of involvement with the project
Local residents	<ul style="list-style-type: none"> • Residents located near the roads used for transporting materials or diversion of traffic 	Directly affected
Land owner	<ul style="list-style-type: none"> • Individuals, legal entities, local administration holding land title documents • Tenants or occupiers without formal rights 	Directly affected
Public facilities	<ul style="list-style-type: none"> • Educational facilities (kindergartens) • Religious entities (mosques) • Medical entities (hospitals, clinics, medical centre) • Utilities (electricity, water supply) 	Indirectly affected
Business and Service Providers	<ul style="list-style-type: none"> • Shops, markets, supermarkets • Petrol stations, car wash & service, others • Restaurants • Financial services (banks) 	Indirectly affected
Administrative Bodies and Authorities	<ul style="list-style-type: none"> • National Authorities <ul style="list-style-type: none"> - Ministry of Public Works and Housing (MoPWH) - Ministry of Education (MoE) - Ministry of Environment (MoEnv) - Water Authority of Jordan (WAJ) - Ministry of Antiquities • Regional authorities • Local authorities <ul style="list-style-type: none"> - Howwara municipal authorities 	Indirectly affected, but may have influence over the implementation of the project
International donors	<ul style="list-style-type: none"> • KfW Development Bank • European Union 	Indirectly affected, but may have influence over

Group of Stakeholders	Stakeholders	Level of involvement with the project
		the implementation of the project
Bodies involved in Project implementation	<ul style="list-style-type: none"> • Construction contractor(s) (management, staff) • Sub-contractor(s) • Supervision contractor (the Engineer) • Suppliers 	Directly affected, but may have influence over the implementation of the project
Non-Governmental Organizations (NGOs) and independent experts	<ul style="list-style-type: none"> • Specialized environmental, social and research organizations, NGOs • Experts on a national and international level 	Indirectly affected
Media	<ul style="list-style-type: none"> • Print media • Radio, TV • Internet sources 	Indirectly affected

Table 4-1: List of concerned stakeholders

Source: Consultant

5. ENVIRONMENTAL AND SOCIAL BASELINE CONDITIONS

This chapter describes the physical, socio-economic and biological baseline of the proposed site, based on the findings of the data collection, field investigations (here IEE) and review of the relevant documents.

5.1. Physical Environment

5.1.1. Soil

It was found that Irbid governorate includes the Chromoxererts soil group, which develops under the xeric soil moisture regime. Such soils are found to be essentially fertile, with a high water holding capacity that supports the cultivation of crops. The soil level in particular is considered to be deep and clayey soils. The dominating subgroups include the Typic and Entic Chromoxererts.

5.1.2. Land Use

The site allocated for the school is owned in full by MoE, and is made of five adjacent plots, No. 210, 211, 212, 213 and 322 in Basin no. 27 totalling an area of 9,017m². The five plots are in the process of being unified in one by MoE. It is a fresh uniform piece of land at the outskirts of a bigger conglomeration with almost unnoticeable slope.

The site is utilized as fertile farm land covered partly by olive trees (plots 210-213) and wheat (plot 322).

The vacant piece of land which has an area of around 4,400m² (plot 322) should be enough to build the intended school. If, during the design phase, additional land area is required, the neighbouring land plots of (210 – 213) planted with olive trees can be used. Cultivated olive trees are in good condition and already used for olive production. If needed, the trees can be safely removed and replanted elsewhere.

Dated 25th of August 2019 a further site visit was conducted to clarify the land use patterns of the Howwara site. The results of which are as follows:

- MoE acquired this land in 2004/2005 from previous owners.
- Since 2004/2005 the MoE did not use the land, therefore, the land owners continued harvesting the olives trees and wheat voluntarily to avoid wasting the produce of these lands. They are in no means using these lands as a main source of income.
- They have continued harvesting without any agreement (neither officially nor unofficially) with MoE.
- The previous land owners have, on their own accord, signed a hand-written letter indicating that they have no objection of the MoE to use this land for constructing school buildings (refer to Annex 3).
- The Local Chief (Mokhtar) of Howwara confirmed that there is no objection to using this land and confirmed that: the land owners have taken it upon themselves to continue harvesting to avoid wasting the produce of the harvest without an official agreement with MoE. Moreover, he signed the document confirming that we had the site visit with him to discuss the land use patters on the Howwara Site refer to Annex 3.
- The land parcel cultivated with wheat has been harvested, the land cultivated with olives trees have not been harvested (harvesting season in October/November 2019), however the Mokhtar has confirmed that the previous land owners understand that their activities shall stop given the construction might begin soon. Therefore, the previous land owners (i.e. the land users are well informed of the upcoming construction activities and do not object to stop their harvesting activities).

5.1.3. Noise and Vibrations

Most of the project area experiences 'typical' noise and vibration levels which are generated from normal human activities and motor vehicles. Noise and vibrations from the industrial area are considered to be low given the small amount of industrial activities present.

Road traffic noise levels are considered significantly below 75 to 80 dB (A), the range of densely travelled roads as established by WHO (1999) as are representative for urban city areas.

Considering the planned school construction and further development of the surrounding residential area some noise and/or vibrations are generated by the construction works itself. But, the scale of noise and vibrations is limited to the direct neighbourhood of the construction site(s) and of temporary character.

Unfortunately, no qualitative and/or quantitative data indicating the noise and/or vibration potential are available.

5.1.4. Water Resources

Surface Water Resources

Based on the Water Master Plan developed by JICA in 2017, the water transmission system to Irbid Governorate including Howwara and Irbid Municipality is presented in Figure 5-1 below.

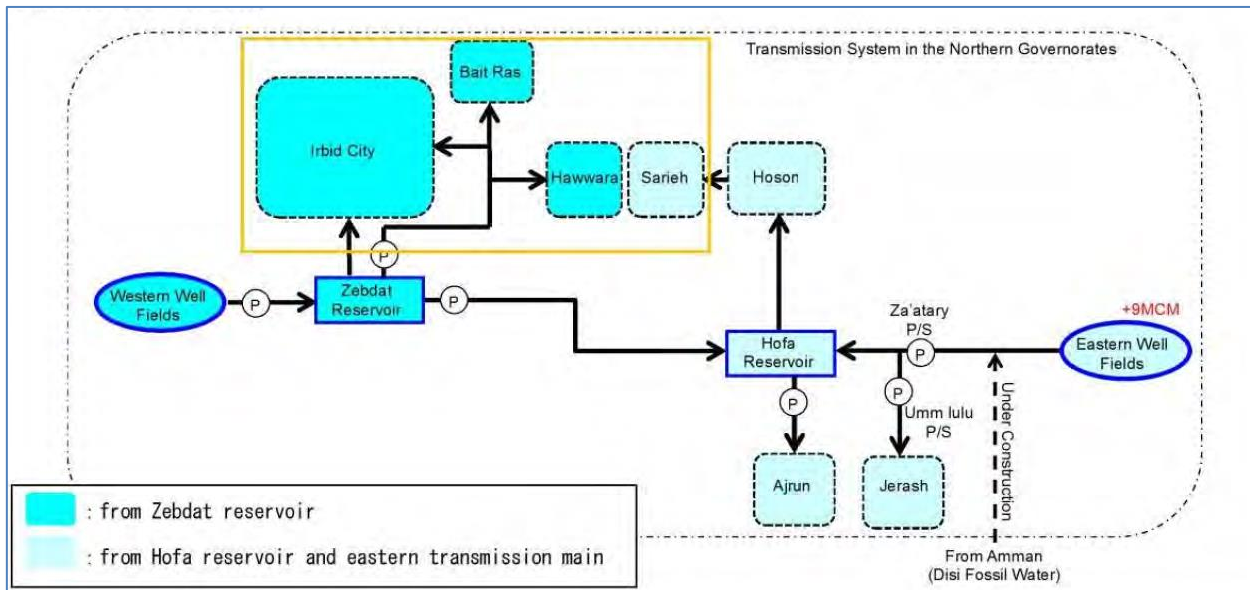

Figure 5-1: Howwara project site water transmission system in Irbid Governorate

Source: Water Master Plan, JICA, 2017

Moreover, the surface water basins within Irbid Governorate include firstly the Yarmouk River Basin, with a total flow of 355 million m³ per year with a base flow of 264 million m³ per year, and a total catchment area of 7,250 km² with only 1,426 km² within the Jordanian borders. Secondly, the Jordan River Basin (specifically the Valley Floor sub-basin), which is located between Lake Tiberius and the Dead Sea, with a total flow of 2.73 million m³ per year. And finally, the North Side Wadi of the Jordan Valley also covers some area within Irbid Governorate, with a total catchment area of 946 km² and total flow of 49.39 million m³ per year. The following Figure 5-2 presents a general overview of the surface water basins in Jordan.

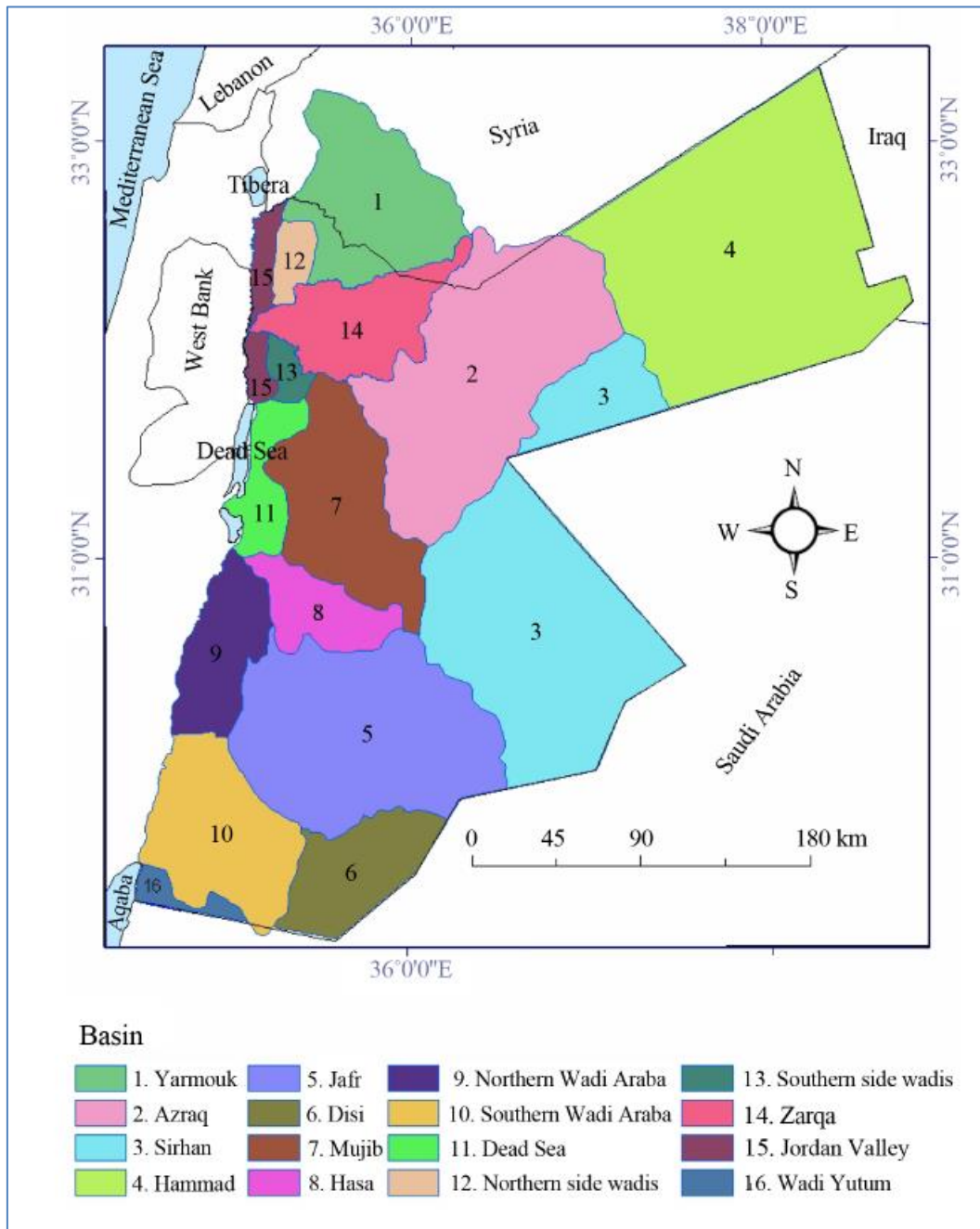

Figure 5-2: Surface Water Basins in Jordan

Source: Water Demand Management in Jordan, Nadhir Al-Ansari¹, N. Alibrahiem, M. Alsaman, Sven Knutsson, 2013

Groundwater Resources

Regarding groundwater sources, the northern governorate of Irbid includes mainly three groundwater basins including Yarmouk, Jordan Valley and the Rift Side Wadi Basins. The safe yield of renewable groundwater for the mentioned basins are 45%, 38% and 19% respectively. Figure 5-3 provides an overview of the groundwater basins in Jordan.

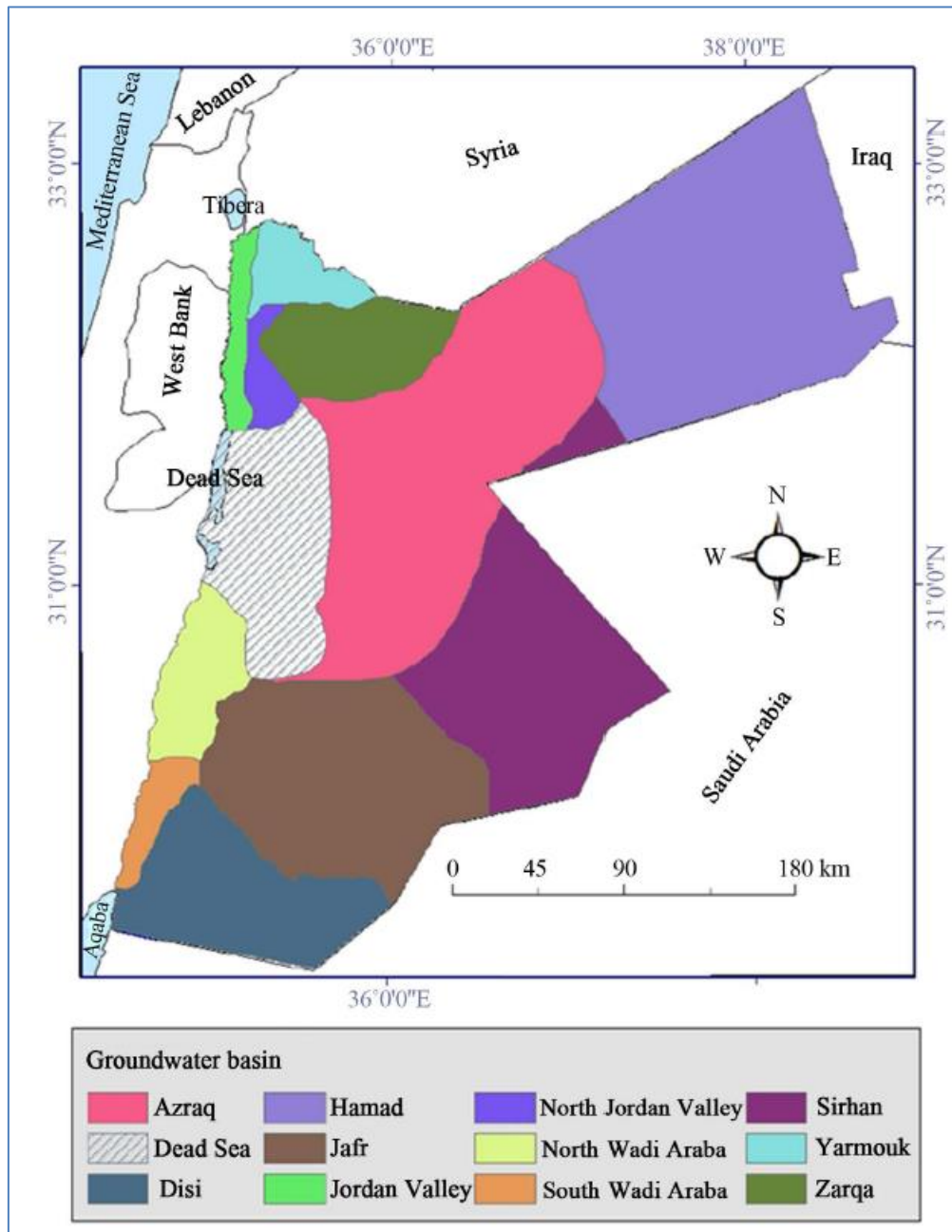

Figure 5-3: Groundwater Basins in Jordan

Source: Water Demand Management in Jordan, Nadhir Al-Ansari¹, N. Alibrahiem, M. Alsaman, Sven Knutsson, 2013.

5.1.5. Air Quality

In general air quality is influenced by anthropogenic activities distinguishing two main sources, namely mobile and stationary sources. Industrial activities are a major source of ambient air pollution arising from stationary sources while motor vehicles account for the majority of the air pollution emissions from mobile sources.

The majority of industries are located in Irbid town. Emissions to the ambient air from industries are pollutants including particulate matter (PM), Carbon monoxide (CO), Carbon dioxide (CO₂), Nitrous oxide (NO_x) as well as Sulphur oxide (SO_x). Prolonged exposure to these activities poses the risk of acute respiratory infections.

Similarly, the main pollutants from exhaust emissions from motor vehicles include Hydrocarbon and Benzopyrene, Phosphorus, Carbon monoxide, Sulphur oxides and Nitrous oxide. Exhaust emissions are highest in urban center and along the major highways and varies according to periods of peak traffic flow.

These conditions described before are not representative for Howwara area, due to the absence of industries and traffic flows concentrating along main roads. Another factor favouring the air quality is the wide, open construction of residential areas allowing a permanent airflow and exchange.

5.1.6. Road Access & Traffic

While the plot is accessible through mainly unpaved-yet roads, there are no dangerous highways around it. The site is located in a residential area surrounded by many vacant land plots that are yet to be developed. The site has two access roads from the north and south sides, with a narrow road from the east side. Figure 5-4 below indicates the roads that are governmentally owned, which ultimately allows the MoPWH to request construction works for paving such roads with no land acquisition process.



Figure 5-4: Road access to School Site No. 2

Source: Department of Land and Survey, DLS, 2019

Due to its characteristics described before road access and traffic is limited to residential traffic and the seasonal use of agricultural machinery such as tractors with diver's equipment and harvester.

Nevertheless, in order to serve as suitable site for a school construction, the awarded Contractor must carefully assess the road networks to specify the most suitable traffic management plan that includes safe access for the Civil Defence Department (CDD), sufficient road width, capacity of roads for children and parents bus drop off avoiding congestions and dangerous situations.

5.2. Socio-Economic Environment

5.2.1. Catchment Area

Upon further investigations to the site, it was made clear to the Consultant that a total of five (5) schools are located within the catchment area of the School Site No. 2 Figure 5-5 below present the details of the schools located within the 1.5km radius, while Figure 5-6 presents their location on the map in respect to School Site No. 2 Howwara Basic Mixed School.

As proposed in the Site Selection Report (SSR) – Volume 1, the proposed Howwara Basic Mixed School shall accommodate a total range of students from 662 (including 50 students at KG levels) up to 730 (including 50 students at KG level) of Jordanian and Syrian nationalities, where one existing school of evening shift will be cancelled.

Needs Assessment in Same Gender Schools of Catchment Area 2 - Howwara Basic Mixed														
No.	National ID No.	School Name	Owned / Rented	1st Shift / 2nd Shift	Gender	No. Class-rooms	Average Area of Classrooms (m ²)	Capacity of Classrooms (Class area/ 1.2 m ²)	Current Average No. of Students / Class	Total No. of Students	Total No. of Syrian Students	School Capacity (class capacity *no. classrooms)	Notes	Located within 1km
1	111117	Howwara Secondary AlShamiah for Girls	owned	1	F	16	28	23	33	523	31	373	Overcrowded (523-373= 150)	Located within 1km
2a	111126	Howwara Basic for Girls	owned	1	F	18	47	39	34	616	22	705	Not crowded (705-616=89) available space for 89 students	Not located within 1km but will impact new school
2b	114197	Howwara Basic Mixed / Syrians	owned	2	F / M	12	47	39	22	259	254	470	To be cancelled	
3	111153	Al Khansaa' Basic Mixed	owned	1	F / M	26	24	20	30	768	5	520	Overcrowded (768-520=248)	Located within 1km
Total in second shift										259	254			
Total in Rented schools										0	0			
Total in overcrowded										398	36	398		
Total current need (from schools that will be replaced)										657	290	Percentage of Syrians in schools that will be replaced		44.0%

Spaces to be covered by increasing occupancy in existing schools	89
Actual no. of school places to be created	568

Study of Opposite Gender Schools in Catchment Area (Boys Schools)														
No.	National ID No.	School Name	Owned / Rented	1st Shift / 2nd Shift	Gender	No. Class-rooms	Average Area of Classrooms (m ²)	Capacity of Classrooms (Class area/ 1.2 m ²)	Current Average No. of Students / Class	Total No. of Students	Total No. of Syrian Students	School Capacity (class capacity *no. classrooms)	Notes	Located within 1km
4	111079	Howwara Basic for Boys	owned	1	M	22	36	30	33	733	46	660	Overcrowded (733-660=73)	
5	111035	Howwara Secondary AlShamiah for Boys	owned	1	M	22	48	40	37	804	28	880	Not overcrowded (880-804=76) available space for 76 students	
Total in catchment area schools										3703	386	Percentage of Syrians in catchment area schools		386 / 3703 = 10.4 %

	Rented
	Second Shift
	Rented + Second Shift
	Overcrowded
	Available Spaces / Same type of School
	Available Spaces / Different Type of Sch
✓	Rented / Second shift / Crowded / Underutilized problem solved
X	Problem unsolved
X	Problem partially solved
 	No problem to solve

Proposed Solutions of Catchment Area Problems on Same Gender Schools 2 - Howwara Basic Mixed												
No.	National ID No.	School Name	Owned / Rented	1st Shift / 2nd Shift	Gender	No. Classrooms	New Average No. of Students / Class	Current Total No. of Students	No. of Moved or Added Students	New Total No. of Students	Notes	
1	111117	Howwara Secondary AlShamiah for Girls	owned	1	F	16	23	523	-150	373	✓	150 students were removed to reach school capacity
2a	111126	Howwara Basic for Girls	owned	1	F	18	39	616	+89	705	✓	89 students were added to reach school capacity
2b	-	-	-	-	-	-	-	-	-	-	✓	259 Second Shift is Cancelled
3	111153	Al Khansaa' Basic Mixed	owned	1	F / M	26	20	768	-248	520	✓	248 students were removed to reach school capacity
(NEW) Howwara Basic Mixed School Actual Need									568			
*Schools of large sizes will not have extra 15% for projected needs within the next 5 years												
Additional 15% for Projected Needs Within Next 5 Years (If School's Size Allows)*=							85	Total Needed Spaces after Adding 15%			653	

Howwara School Size Recommendation															Total	Total With KG	
Grade	KG	1 st	2 nd	3 rd	4 th	5 th	6 th	7 th	8 th	9 th	10 th	11 th	12 th				
Gender	Mixed	Mixed	Mixed	Mixed	Girls	Girls	Girls	Girls	Girls	Girls	Girls	Girls- science stream	Girls- art stream	Girls- science stream	Girls- art stream		
No. of Class-rooms	2	2	2	2	1	1	1	1	1	1	1	1	1	1	1	17	19
Total No. of Students (based on 36)	50	72	72	72	36	36	36	36	36	36	36	36	36	36	36	612	662
Total No. of Students (based on 40)	50	80	80	80	40	40	40	40	40	40	40	40	40	40	40	680	730

Figure 5-5: Details of Schools located within a 1.5km radius of the School Site No.2

Source: School Selection Report (SSR) – Volume 1, Dorsch, 2019

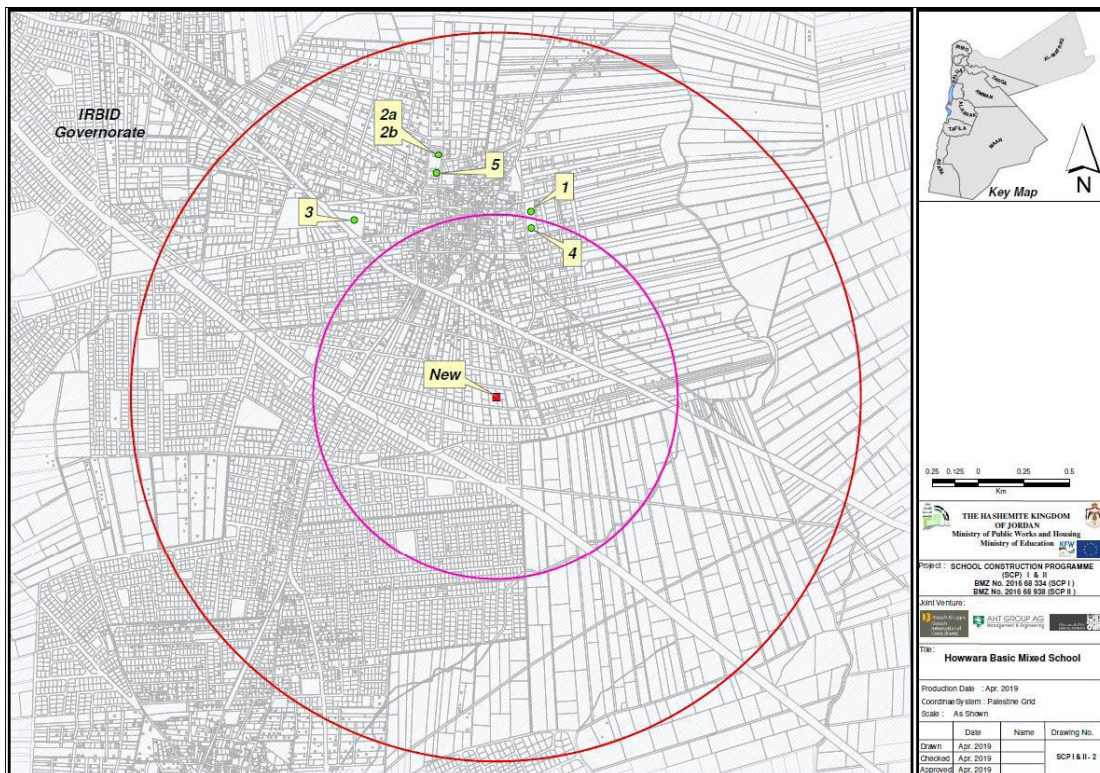

Figure 5-6: Catchment Area of School No. 2 Howarra Basic Mixed School

Source: School Selection Report (SSR) – Volume 1, Dorsch, 2019

5.2.2. Access to Medical, Communal and Religious Services

The next mosque, Al Iman Mosque, is some 750m away from the proposed site as shown in the next Figure 5-7



Figure 5-7: Location of closest mosque (Al Iman Mosque) to Howwara project site

Source: Google Earth, 2019

Around the proposed Howwara site, no medical and communal service facilities can be found. They are located in the town.

5.2.3. Small Scale Business

The proposed site is located in a residential area of rural character and still subject to further development. Main economic activity is small scale agriculture, here mainly the cultivation of olive trees, grain and vegetables. In the surrounding area of Howwara site no typical small scale business such as shops, reseller, car repair, etc. can be found.

5.2.4. Overview of Demographic Profile

Given that Howwara is located within Qasabet Irbid, the available statistics as per the Department of Statistics for the year 2015 are presented below. Coordination with DoS is underway to collect the latest census of the Kingdom with more details than presented in the published Statistical yearbook of 2017, as it only provides demographics on a governorate and city level, not including localities and villages.

Locality	Jordanian	Syrian	Others	Total
Howwara	16,824	5,706	1,399	23,929

Table 5-1: Population statistics of Howwara

Source: DoS 2015

In regards to livelihood, the typical sources of income in small villages are limited to farming, small to medium sized industrial activities and grazing activities. As per the site visits conducted by the technical team and the E&S Team, the Howwara site is currently being cultivated with wheat and olive trees. Tenants (formal or informal) shall be notified of proposed construction works and an agreement achieved regarding land use until the start of construction. The tenant shall be notified in time (may be one year) prior to construction to avoid replanting of the land and subsequent delay of the project.

5.3. Biological Environment

Considering the natural biological environment, the flora / fauna information at the concerned site can be summarized as follows:

- The proposed site is not located in a preserved area.
- No threatened, rare or endangered species of fauna or flora were registered or known to exist around the site.
- No sensitive or fragile habitats were noted in relation to the extent and magnitude of the envisaged works.
- No species of fauna or flora that could be exploited for commercial purposes have noted in proximity to the proposed works.
- The current degree and extent of the proposed works does not interfere with any protected area.

6. IMPACT IDENTIFICATION AND ANALYSIS

6.1. Expected Environment and Social Impacts

The implementation of the School Construction Programme / School No. 2 – Howwara Basic Mixed School is associated with impacts mainly occurring during the construction phase of the Project. Typical negative impacts are related to:

- Health and safety issues including possible dust and noise emissions from any excavations, concrete works and the transportation of soil, waste and other materials affecting the public and the employees of the construction contractor.
- Environmental pollution from the all forms of construction and waste generated when performing the works.

During the operation phase of the Project, limited adverse impacts are anticipated to arise. Typical negative impacts are related to:

- Health and safety issues including maintenance works for the school, traffic issues that might affect the local community and employees of the school.
- Constraints on available utilities including water resources, waste disposal sites, etc.

6.2. Impact Significance Assessment

This type of potential negative impacts during both phases can be effectively controlled, reduced and/or mitigated. Corresponding environmental and social requirements will be integrated in the construction contractor’s obligations for daily consideration and monitoring, as well as the operator’s obligations towards proper management of the school. Considering the benefits for the concerned community (access to modern school facility; development of future opportunities for children) and the relatively short duration of the works the overall conflict potential is suggested as low.

The overall significance of impacts has been determined by combining the perceived ‘Likelihood of occurrence’ of the source of the impact in combination with the corresponding impact ‘Consequence’ describing the severity of the impact, Significance describing the level of required mitigation measures, the Spatial Influence, describes the proximity of the impact, Temporal Influence describes the duration of the impact, and finally Reversibility describes the ability to return to original conditions after implementing mitigation measures. Table 6-1 below provides the detailed classification of impacts.

Impact Criterion	Effect on Environment	Classification of Effect	
		Expression	Effect description
Likelihood of occurrence	What certainty of occurrence is associated with impact?	Unlikely	Probably will not occur
		Likely	May occur
		Certain	Will occur
Consequence	How severe the impact will be?	Marginal	Little impact
		Critical	Moderate impact
		Severe	High impact
Significance	How important is impact in Project design?	Low	Impact of little importance, needs limited mitigation
		Medium	Impact has influence and requires mitigation
		High	Impact of great importance, mitigation a must
Spatial influence		Local	Within the site premises

Impact Criterion	Effect on Environment	Classification of Effect	
		Expression	Effect description
	How the impact shall be extended spatially?	Regional	Within the surrounding area of the project
		Global	Extends beyond the surrounding area
Temporal influence	How the impact shall extend over time?	Short term	The impact shall last short period of time
		Medium term	The impact shall last medium period of time
		Long Term	The impact shall be permeant
Reversibility	Does the influence of the impact can be removed once the impact end or the influence will remain?	Reversible	The influence of the impact can be reversed
		Irreversible	The influence of the impact cannot be reversed and shall be permanent

Table 6-1: Classification of impacts

6.3. Proposed Topics to be Scoped Out

With reference to the analysis of the legal and institutional framework (Chapter 3) and collected information in the baseline (Chapter 5) there are certain topics considered of not relevant or with less importance to the project and therefore proposed to be scoped out.

Topics proposed to be scoped out

Given the initial analysis and applicability of the above mentioned standards, ESS 7 and ESS 9 are not applicable based on the following justifications.

- ESS 7 “Indigenous Peoples/Sub-Saharan African Historically Underserved Traditional Local Communities” is not applicable, as there are no such groups or communities within the project site area nor are such groups affected by the Project.
- ESS 9 “Financial Intermediaries” is not applicable, as there are no FIs involved in this Project.
- KfW Resettlement Policy Framework, as the implementation of the project does not require informal resettlement.

Topics of less importance and therefore proposed to be scoped out

- Surface and groundwater resources as there are no such resources in the vicinity of the project site,
- Biodiversity conservation and sustainable management of living natural resources. Not relevant, given that there are no threatened, rare or endangered species of fauna or flora were registered or known to exist around the site.
- Climate change assessment (climate check).

6.4. Impact Categorisation

In this Chapter a detailed elaboration of potential impacts associated with the implementation of the Howwara Basic Mixed School project and under consideration of the stakeholder consultation process has been undertaken.

In result, the Project is expected to have no or only minor adverse environmental and social impacts or risks and the implementation and operation does not require any particular protection, compensation or

monitoring measures. Identified impacts will mainly occur during the construction phase of the Project and can be effectively mitigated.

Responsive actions (mitigation measures > ESMP > stakeholder involvement) are defined under Chapters 7 and 8.

Table 6-2 and Table 6-3 provides a summary of the potential environmental and socio-economic impacts associated with the project's planned and unplanned activities during the construction phase and operation phase respectively.

No.	Resource Area	Assessment Rationale	Potential Impact(s)	Likelihood	Consequence	Spatial Influence	Temporal Influence	Reversibility	Impact Significance
1	Air Quality and Dust	<ul style="list-style-type: none"> Dust and emission from construction activities and equipment shall affect the work environment within the project site Dust and emission from moving vehicles on surrounding roads shall affect surrounding residential area 	Local degradation to air quality due to exhaust emissions	Very Likely	Marginal	Local	Short term	Reversible	Medium
			Local degradation to air quality due to dust generation from construction activities.	Very Likely	Marginal	Local	Short term	Reversible	Medium
2	Noise	<ul style="list-style-type: none"> Noise from construction activities and equipment shall affect the work environment within the project site Noise from moving vehicles on surrounding roads shall affect surrounding residential area 	Noise pollution due to construction activities such as excavation, etc. and use to heavy machineries, vehicle and equipment operation.	Certain	Critical	Local & regional	Short term	Reversible	High
3	Land and Soil	<ul style="list-style-type: none"> The informal agriculture land use will be lost as a result of the project. Soil disturbance due to excavation and construction works Soil pollution from construction equipment and construction vehicles within the site 	Loss of agricultural land	Certain	Critical	Local	Long Term	Irreversible	High
			Loss of olive trees	Likely	Critical	Local	Long Term	Irreversible	High
			Removal of soil due to construction activities, thus causing erosion.	Likely	Marginal	Local	Long Term	Irreversible	Low
			Contamination of soil due to accidental spillage/leakage of chemicals or oils stored on site or used during construction or rupture of	Likely	Critical	Local	Long Term	Irreversible	Medium

No.	Resource Area	Assessment Rationale	Potential Impact(s)	Likelihood	Consequence	Spatial Influence	Temporal Influence	Reversibility	Impact Significance	
			fuel storage tanks in construction site.							
			Local degradation of soil quality due to potential sewage generation.	Unlikely	Marginal	Local	Long Term	Irreversible	Low	
			Local degradation of soil quality due to wastewater losses such as from concrete mixer.	Unlikely	Marginal	Local	Long Term	Irreversible	Low	
4	Water Resources	<ul style="list-style-type: none"> ▪ Construction activities will result in the increase of runoff instances during rainfall events. ▪ Water demands during construction phase are expected to increase to meet the demands of the additional activities and the demands of workers on site. ▪ Given that there are no surface water sources within the proximity of the site, there are no direct impacts on such sources. 	Increased surface water runoff leading to erosion and sedimentation during and after significant rainfall events.	Unlikely	Marginal	Local & Regional	Long Term	Irreversible	Low	
			Increased water demand during construction phase, which might lead to constraints on local users.	Likely	Marginal	Local	Short term	Reversible	Low	
			Local degradation of surface water quality due to accidental spillage/leakage of oil, chemicals or liquid fuels.	Not relevant						
			Surface water pollution due to disposal of construction wastes.	Not relevant						
5	Waste Generation and Disposal	Construction activities will result in the increase generation of hazardous & non-hazardous waste.	Improper management of hazardous and non-hazardous waste generated at site leading to impacts on soil, water and visual environment and health and	Likely	Critical	Local & Regional	Short – Medium term	Reversible	Medium	

No.	Resource Area	Assessment Rationale	Potential Impact(s)	Likelihood	Consequence	Spatial Influence	Temporal Influence	Reversibility	Impact Significance
			safety of construction workers and public						
6	Aesthetics	Due to construction machinery and activities, the local aesthetics will be affected.	Visual intrusion and aesthetic interference due to potential generation of waste (spoil) and littering in the project area.	Likely	Marginal	Local & Regional	Short term	Reversible	Low
7	Socio-economic Issues	The Project is expected to result in short term disturbance to the business-as-usual (BAU) conditions of the local community during the construction phase. Nonetheless, the Project is expected to contribute to improve the access to education in the area, in addition to providing job opportunities.	Physical and psychological strain to women due to presence of (foreign) workers. Physical and psychological strain to children playing in the vicinity of the construction work and personnel.	Likely	Marginal	Local & Regional	Short term	Reversible	Low
			Emission of dust from construction works which may cause stress to local community and businesses in the area	Likely	Critical	Local & Regional	Short term	Reversible	Medium
			Loss of agricultural land for income generation.	Likely	Critical	Local & Regional	Long term	Irreversible	High
			Disturbance of women's wellbeing and social life.	Unlikely	Marginal	Local & Regional	Short term	Reversible	Medium
			Limitation of farmer's access to activities due to road closure, piling of excavated material on sides to trenches which may lead to disruption of existing businesses.	Unlikely	Marginal	Local & Regional	Short term	Reversible	Low
			Workforce employment (men and women)	Certain	Positive	Local & Regional	Long term	Irreversible	Positive
8		▪ The construction activities may have a	Impact to public due to dust generation, noise	Likely	Critical	Local	Short term	Reversible	Medium

No.	Resource Area	Assessment Rationale	Potential Impact(s)	Likelihood	Consequence	Spatial Influence	Temporal Influence	Reversibility	Impact Significance
	Community Health and Safety	<p>temporary impact on the community H&S due to the presence of the machinery.</p> <ul style="list-style-type: none"> Spread of COVID-19 amongst construction workers 	<p>generation, traffic accidents due to road blocks, etc.</p> <p>Impact on construction workers as well as the public due to the spread of COVID-19</p>	Likely	Critical	Local	Short – Medium term	Reversible	Medium
9	Occupational Health and Safety	The construction activities may increase the risk of the workers' H&S to some extent due to the possibility of injuries and accidents.	<p>Impact to public due to dust generation, noise generation, traffic accidents due to road blocks, etc.</p> <p>Risk to occupational health and safety from construction activities such as excavation, concrete works, confined space entry, handling of hazardous materials and chemicals, manoeuvring of construction equipment and machinery, risk of exposure to injuries.</p> <p>Potential accidents from obstructed pedestrian and vehicular access, lack of sufficient signage barricades, warning, lights and other safety precautions that are required by the contractor.</p>	Likely	Critical	Local	Short term	Reversible	Medium
10	Flora and Fauna	Construction activities are expected to disturb the existing ecosystem, in addition to the possible impacts due to improper management of generated waste and its disposal.	Loss of (protected) terrestrial species	Not relevant, given that there are no threatened, rare or endangered species of fauna or flora were registered or known to exist around the site.					

No.	Resource Area	Assessment Rationale	Potential Impact(s)	Likelihood	Consequence	Spatial Influence	Temporal Influence	Reversibility	Impact Significance
11	Traffic	Construction activities are expected to disturb the existing traffic conditions	Traffic and road accessibility will be disrupted with the possibility of creating congestions at peak hours.	Likely	Critical	Local & Regional	Short term	Reversible	Medium

Table 6-2: Summary of environmental and socio-economic impacts during construction phase

No.	Resource Area	Assessment Rationale	Potential Impact(s)	Likelihood	Consequence	Spatial Influence	Temporal Influence	Reversibility	Impact Significance
1	Land and Soil	The informal agriculture land use will be lost as a result of the project during its operational phase.	Loss of agricultural land	Certain	Critical	Local	Long Term	Irreversible	High
			Loss of olive trees	Likely	Critical	Local	Long Term	Irreversible	High
2	Water Resources	<ul style="list-style-type: none"> ▪ Increased runoff is expected in the area during rainfall events. ▪ Water demands during operation phase are expected to increase to meet the demands of the additional activities and the demands of workers on site. 	Increased surface water runoff leading to erosion and sedimentation during and after significant rainfall events.	Unlikely	Marginal	Local & Regional	Long Term	Irreversible	Low
			Increased water demand during construction phase, which might lead to constraints on local users.	Likely	Marginal	Local	Short term	Reversible	Low
3	Waste Generation and Disposal	The amounts of waste generated and disposed during operational phase may increase.	Improper management of hazardous and non-hazardous waste generated at the Project site and the local utilities may lead to adverse impacts.	Likely	Critical	Local & Regional	Short – Medium term	Reversible	Medium
4	Aesthetics	Due to presence of the school building, the aesthetics of the local area is altered to some extent	Visual intrusion and aesthetic interference is considered to be negligible as the site is located in a residential area.	Likely	Marginal	Local & Regional	Long Term	Reversible	Low
5		The Project is expected to result in short term disturbance to the	Potential of increased traffic in the local area	Likely	Critical	Local	Long Term	Reversible	Medium

No.	Resource Area	Assessment Rationale	Potential Impact(s)	Likelihood	Consequence	Spatial Influence	Temporal Influence	Reversibility	Impact Significance
	Socio-economic Issues	business-as-usual (BAU) conditions of the local community during the operational phase. Nonetheless, the Project is expected to contribute to improve the access to education in the area, in addition to providing job opportunities.	due to the operation of the School. Risk for children and parents at bus drop offs due to insufficient road width causing congestions and dangerous situations.						
			Small scale business activities to increase with higher income generation	Certain	Positive	Local	Long term	Irreversible	Positive
			Workforce employment (men and women)	Certain	Positive	Local & Regional	Long term	Irreversible	Positive
6	Occupational Health and Safety	<ul style="list-style-type: none"> ▪ During the operational phase there might be some adverse impacts on workers' H&S. ▪ Spread of COVID-19 amongst workers 	Risk to occupational health and safety from maintenance activities.	Likely	Critical	Local	Short term	Reversible	Medium
			Impact on workers as well as the public due to the spread of COVID-19	Likely	Critical	Local	Short – Medium term	Reversible	Medium
7	Community Health and Safety	<ul style="list-style-type: none"> ▪ Spread of COVID-19 amongst students and school's staff ▪ Spread of COVID-19 amongst workers 	Impact on school students and staff as well as the public due to the spread of COVID-19	Likely	Critical	Local	Short – Medium term	Reversible	Medium
8	Flora and Fauna	The activities during the operational phase to disturb the existing ecosystem, in addition to the possible impacts due to improper management of generated waste and its disposal.	Loss of (protected) terrestrial species	Not relevant, given that there are no threatened, rare or endangered species of fauna or flora were registered or known to exist around the site.					

No.	Resource Area	Assessment Rationale	Potential Impact(s)	Likelihood	Consequence	Spatial Influence	Temporal Influence	Reversibility	Impact Significance
9	Traffic Control	Daily activities around the school premises would affect traffic and accessibility within the area	Traffic and accessibility shall be properly designed in order to provide safe access to the school and allow smooth traffic control	Likely	Critical	Local	Short term	Reversible	Medium

Table 6-3: Summary of environmental and socio-economic impacts during operation phase

7. ENVIRONMENTAL AND SOCIAL MANAGEMENT PLAN

The Environmental and Social Management Plan (ESMP) identifies measures to address any potential environmental and socio-economic impacts that might occur during the implementation of the School Construction Programme / School No. 2 – Howwara Basic Mixed School.

Responding to the environmental and socio-economic impacts, detailed mitigation measures have to be identified and evaluated in order to avoid, reduce or remedy the impacts during the construction phase.

The objective of this ESMP is to ensure the integration of environmental and social requirements and proposed mitigation and monitoring measures into the construction contractor's obligations.

The ESMP shall be fully integrated in the construction activities, hereby addressing the responsibilities of the construction contractor (the Contractor), the Engineer and the Employer.

Furthermore, an ESMP has been developed for impacts resulting from the operational phase, which shall be fully integration in operation activities that

Responding adequately to the complex nature of the envisaged school construction implementation the ESMP is referring to the following issues:

- Environmental and Social Mitigation Measures during Construction,
- Environmental and Social Mitigation Measures during Operation,
- Environmental and Social Quality Monitoring during Construction
- Environmental and Social Quality Monitoring during Operation, and
- Obligations, roles and responsibilities amongst concerned parties.

In the light of the COVID-19 outbreak, KfW Development Bank and the Government of Jordan issued guidance documents on preventing and managing related Environmental, Social, Health and Safety (ESHS) aiming to minimize the risks potentially caused by the virus as introduced under Chapters 3.1 and 3.3. These guiding documents have to be respected by all involved stakeholders; where necessary more detailed actions have to be taken to comply with the imposed requirements.

7.1. Contractors, Engineers and Employer Roles and Responsibilities

Employer's Arrangements

The Employer has the overall responsibility for environmental and social management during the construction phase of the Project. This includes the following responsibilities:

- Ensuring compliance with all relevant national legislation, relevant KfW Sustainability Guideline provisions as well as with the environmental controls and mitigation measures contained in this ESMP.
- Ensure that the design and planning is in compliance with national requirements and aligned with international best practice.
- Supervise and pro-actively monitor the implementation of the Stakeholder Engagement Plan.
- Monitoring the performance of contractors and sub-contractors used for providing workforce, supplies and services.
- Acting as point of contact for consultation and feedback to stakeholders and the public (stakeholder engagement).
- Where possible, the Employer shall facilitate the issuing of the relevant permits, approvals etc. from the relevant authorities. Such assistance shall not however relieve the Contractor of his responsibilities under the contract to obtain such approvals.

Contractor's obligations

The Contractor shall comply with the environmental and social requirements contained in the construction contract. In particular, the Contractor shall:

- Ensure compliance with relevant KfW Sustainability Guideline provision.
- Ensure environmental awareness among his personnel, suppliers and sub-contractors so that they are fully aware of, and understand these environmental and social requirements.
- Strictly adhere to the provisions of the KfW 'Standard Bidding Document for Procurement of Works' issued in its latest version (currently January 2019), especially provisions with regard to Environmental, Social, Health and Safety (ESHS) related instructions.
- Prior to the commencement of works the Contractor shall submit an Environmental and Social Management Plan (ESMP) for the Engineer's approval indicating how the Contractor will comply with the contract requirements for execution of the works. The CESMP shall be properly implemented by the Contractor during the contract.
- Prior to the commencement of works the Contractor has to nominate the following staff:
 - ESHSE Manager
 - Environmental and Social (ES) Manager
 - Health and Safety (HS) Manager
 - External Stakeholders Relations Manager
 - ESHS Supervisor
 - Community Liaison Officer
- The Contractor has to pro-actively contribute to the implementation of the Stakeholder Engagement Plan. For his workers and all workers of assigned sub-contractors the Contractor has to implement a grievance mechanism.
- Notify the Engineer immediately in the event of any accidental infringements of these environmental requirements to enable appropriate remedial action to be taken immediately by the Contractor.
- Notify the Engineer, at least 7 working days in advance, of any activity it has reason to believe may have significant negative impacts, so that mitigation measures may be implemented in a timely manner.
- The Contractor shall maintain close liaison with utility companies and contractors employed by the other organizations who are carrying out works on or adjacent to the site. The Contractor shall ensure that the progress of the works is not adversely affected by the activities of such other parties and vice versa. The Contractor shall inform the Engineer when the potential disruptions due to the other parties are anticipated.
- Strictly adhere health and safety instructions and guidelines related to COVID-19 including Guide 12 set by the Government of Jordan and KfW guidelines.

Engineer's Role and Duties

The Engineer will designate all working areas, and monitor and enforce the Contractor's compliance with these environmental and social requirements. In particular, the Engineer will:

- Ensure compliance with relevant KfW Sustainability Guideline provision.
- Strictly adhere to the provisions of the KfW 'Standard Bidding Document for Procurement of Works' issued in its latest version (currently January 2019), especially provisions with regard to Environmental, Social, Health and Safety (ESHS) related instructions.
- Strictly adhere to Environmental, Social, Health and Safety (ESHS) provisions imposed by the national legal and regulatory framework.
- Enforce and adhere to all health and safety instructions and guidelines related to COVID-19 issued by the government of Jordan as well as those issued by KfW and ensure proper ESHS monitoring.
- Respect provisions of ILO Convention No. 87 (Freedom of Association and Protection of the Right to Organize Convention) and propose mitigative measures allowing full compliance to the Contractor's (including also all sub-contractors) workers and staff.

- Pro-actively manage the implementation of the provisions of the hereafter ESMP.
- Communicate to the Employer, at least 7 working days in advance, any proposed actions which may have negative impacts on the environment.
- Maintain a record of complaints from the public, and communicate these complaints to the Contractor and Employer (grievance mechanism).
- Facilitate communication between all role players in the interest of effective environmental management.

7.2. Environmental and Social Mitigation during Construction & Operation

The mainly short-term negative environmental impacts, which inevitably occur during the construction works, will be minimized by propped planning and application of preventative measures, and will be mitigated by restorative actions after the works are completed as listed in Table 7-1. Additionally, Table 7-2 defines the mitigation measures that shall be implemented during the operational phase to mitigate the anticipated adverse environmental and social impacts.

In practice, proper planning means that environmental and social requirements become an integrative part of the construction contractor's obligations and have to be approved by the supervision engineer and competent authority/ies prior to any construction works.

No.	Aspect	Mitigation measures	Responsibility
Physical Environment			
1	General	<ul style="list-style-type: none"> The provisions listed hereafter shall apply to and be binding upon the Contractor for any part of the works on the site and the subcontractors. The main contractor is responsible to instruct sub-contractors accordingly and to supervise compliance. The Contractor shall ensure that proper and adequate provisions to this end are included in all subcontracts. The Contractor shall employ appropriate construction methods and carry out the works in a manner as to minimize any adverse impacts on environmental and social media listed hereafter within or outside any construction sites during the contract implementation. The Contractor shall submit an Environmental and Social Management Plan (CESMP) for the Engineer's approval indicating how the Contractor will comply with the contract requirements for execution of the works. The CESMP shall be properly implemented by the Contractor during the contract. A grievance mechanism for concerned stakeholders and workers has to be in place. The Contractor shall comply with the KfW Specifications for Project Area Environmental, Social, Health and Safety Management (ESHS). 	Contractor Engineer
2	Air and Dust	<ul style="list-style-type: none"> The Contractor shall use heavy equipment, machinery, and fuels in compliance with national regulations. The Contractor shall perform regular maintenance on all equipment, vehicle and machinery to prevent air emissions. The Contractor shall limit idling of engines when not in use. The Contractor shall make sure that any vehicle or equipment leaving the project area is cleaned of loose debris. Additionally, vehicles and equipment shall be covered to avoid dust generation. The Contractor shall use dust suppression measures on unpaved roads, excavations, stockpiles, and for transport of excavated material to reduce airborne particulates areas and/or sensitive receptors during windy conditions and when needed. The Contractor shall store cement, sand, or other such fine-grained material in manner to prevent wind erosion and dust. Construction vehicles shall comply with speed limits. Speed limits for heavy vehicles within construction site shall be restricted to 20 km/hr. Vehicle and machinery movements during construction shall be restricted to designated routes at all times where practicable. No stockpiling of fine material is allowed within the construction sites. Spillage of materials on roads or pathways shall be cleaned up promptly in accordance with the spill prevention and response plan that shall be developed by the Contractor as part of the CESMP. 	Contractor

No.	Aspect	Mitigation measures	Responsibility
3	Noise and Vibration	<ul style="list-style-type: none"> • The Contractor shall use heavy equipment, machinery, and fuels in compliance with national regulations. The contractor shall perform regular maintenance on all equipment, vehicle and machinery to prevent noise emissions. • The Contractor shall limit idling of engines when not in use to reduce its contribution to noise emissions. • Contractor shall take reasonable measures, such as installing acoustic screens or close barricades, to maintain noise levels within the national requirements at all construction sites. If such measures are not reasonable, the contractor shall try to minimize disruption through other means such as scheduling noisy activity during less sensitive times in consultation with the sensitive receptors or using alternative techniques that create less noise. • Construction activities are prohibited between 8:00pm and 6:00am, according to the 2003 Instruction for Reduction and Prevention of Noise. Moreover, construction activities shall be avoided on Fridays (weekend in residential areas). • Restrict level of noise not higher than 55 dB during day time and not higher than 45 dB during night activities (if any). • The Contractor shall provide 24 hours advance notification of construction schedule and activities with potential disturbance to nearest residences and public facilities (i.e. schools, hospitals, mosques etc.) which are abutting to the proposed alignment. • The Contractor shall take responsibility for rectifying damages caused by vibration generated from or by the use of any equipment, machinery, and haulage vehicles. 	Contractor
4	Land and Soil	<ul style="list-style-type: none"> • The Contractor shall adopt soil conservation methods during the entire length of the project to reduce the area of destruction during trenching/excavation works. • Upon completion of trenching/excavation works, the Contractor shall restore disturbed areas to their original condition. • Machineries and equipment shall be checked by the Contractor on daily basis to ensure that there is no leak of oil, fuel, greases or other liquids. If leaks are detected, machineries and equipment shall not be operated until repaired. • Contractors shall use impervious drip trays under portable equipment such as mobile generators and pumps to contain any spills or leaks. Contractor shall carry out all re-fuelling in designated areas with impervious surface. Contractor shall ensure no spills of fuel. • All chemicals shall be stored in dedicated areas in tightly closed containers and shall be protected from adverse weather condition. • A spill prevention and response plan shall be prepared by the contractor as part of the CESMP in order to control any inadvertent leakage or spillage. Spill response measures shall be implemented (as necessary) to contain and clean up any contaminated soil. 	Contractor

No.	Aspect	Mitigation measures	Responsibility
		<ul style="list-style-type: none"> Any spilled chemical shall be immediately collected and disposed of in accordance with Spill Prevention and Response Plan. Tenants (formal or informal) shall be notified of proposed construction works and an agreement achieved regarding land use until the start of construction. The tenant shall be notified in time (may be one year) prior to construction to avoid replanting of the land and subsequent delay of the project. 	
5	Water Resources	<ul style="list-style-type: none"> All chemicals shall be stored in dedicated areas in tightly closed containers and shall be protected from adverse weather condition. A spill prevention and response plan shall be prepared by the Contractor as part of the CESMP in order to control any inadvertent leakage or spillage. Spill response measures shall be implemented (as necessary) to contain and clean up any contaminated soil. Any spilled chemical shall be immediately collected and disposed of in accordance with Spill Prevention and Response Plan. Contractor shall direct contaminated wastewater from washing/maintenance to a drain pit in the construction workshop, collected by a vacuum truck and transported to the nearest approved municipal waste facility. Contractor shall provide workers with and inform them of nearby available sanitation facilities to avoid contamination from any human wastes. 	Contractor
6	Waste Generation and Disposal	<ul style="list-style-type: none"> A dedicated waste management plan shall be developed and implemented based on a minimization approach and high-quality housekeeping practices. The Contractor shall segregate storage for different types of wastes, such as hazardous, non-hazardous recyclable construction material, plastic, paper, etc. to facilitate proper disposal as per waste management plan. If applicable, the Contractor shall provide a separate storage area for hazardous materials. The hazardous materials/products must be labelled with proper identification of its hazardous properties. Chemical waste shall be stored in accordance with the provisions of Material Safety Data Sheets (MSDS). The Contractor shall keep MSDS onsite. The Contractor shall provide trash bins within each construction site so as to prevent littering in the project area and surrounding areas. The Contractor shall establish regular intervals for waste collection and disposal as per waste management plan. The sanitary and organic wastes shall be collected and disposed daily. Inert waste generated from excavation activities shall be recycled to the extent possible, sold to contractors or disposed of to a designated landfill. 	Contractor

No.	Aspect	Mitigation measures	Responsibility
		<ul style="list-style-type: none"> The Contractor shall provide adequate toilet facilities at the site. Fixed or portable chemical toilets shall be provided wherever needed. Wastewater shall be collected in a septic tank to be installed on site and removed after the completion of construction activities of that specific area. 	
7	Visual and Aesthetic	<ul style="list-style-type: none"> The Contractor shall ensure general cleanliness and good housekeeping practice at construction sites at all times. Littering in the project area and surrounding areas shall be prohibited. Contractor shall provide trash bins within each construction site so as to prevent littering in the project area and surrounding areas. The Contractor shall progressively rehabilitate disturbed areas; repave streets to the full width after relevant works have been completed. Contractors shall stabilize and plant any disturbed areas. All these activities shall be conducted at the Contractor's own expense. 	Contractor
Socio-Economic Environment			
8.	Socio-economic and Social Disturbance	<ul style="list-style-type: none"> The Contractor shall maintain open communications with the local municipality and concerned residents (erect notification boards at construction site providing information about the project and contact numbers). Local residents are to be informed about construction and work schedules, interruption of services and demolition with a 7 days notification in advance. A grievance mechanism for concerned community and individuals has to be in place. Wherever sidewalks or private roads have been removed for purposes of construction, the Contractor shall place suitable temporary sidewalks or roadways promptly and shall maintain them in satisfactory condition Once the construction plan is issued, the Contractor shall hold public meetings to announce construction plan details (time and duration, stages, etc.). Contractor shall demonstrate full commitment to provide safe and easy access to hospitals, mosques, churches (if any), businesses / business owners to their work places whose business may potentially be affected with construction works. If relevant, the Contractor shall ensure that bridges with rails are conveniently placed over trenches especially in front of businesses that require car access into the establishment (gas stations, car maintenance shops, etc.). If relevant, olive trees shall be safely removed and replanted at other suitable/designates sites after coordination with MoE (site owner). The replanting shall be only allowed after the harvesting period. The loss of trees has to be compensated at replacement value. The Contractor shall obtain work permit from the local authorities to remove or disturb any existing survey markers or other street or roadway markers and are to be restored after work completion. Contractor shall confirm notification of tenant – one year prior to construction activities to avoid impact on livelihoods and delay of the project. 	Contractor

No.	Aspect	Mitigation measures	Responsibility
9.	Community Health and Safety	<ul style="list-style-type: none"> • The Contractor shall be responsible for the protection of the public health from any dangers associated with construction activities, and for the safe and easy passage of pedestrians and traffic in areas affected by his activities. • The Construction vehicles shall comply with speed limits. Speed limits for heavy vehicles within construction site shall be restricted to 20 km/hr. • Ensure that the consultations involve poor households, women, persons with disabilities, the elderly and illiterate persons to ensure the information reaches them and they are aware of the project's specifics before the onset of the project. • If relevant, the Contractor shall install fences, barriers, dangerous warning/prohibition signs around the construction area. Traffic control measures shall be implemented including road and canal signs and the use of flag persons to warn of dangerous conditions. • The Contractor shall ensure that no children are allowed to be around construction activities in particular during excavation and the installation of structures. • Necessary measures shall be taken to ensure that presence and demeanour of construction workers is not threatening sexually or physically women and children under any circumstance. This shall include sensitization of the workers and the community on appropriate behaviours, expectations, and disciplinary actions against workers who do not follow the established protocol. • Any excavations, material dumps, or other obstructions likely to cause injury to any person or thing shall be suitably fenced off and at night marked by red warning lights. • If relevant, the Contractor shall make available a maintenance crew to repair immediately any water or wastewater pipelines which is broken due to excavation works. The Contractor shall coordinate repair works in close cooperation with the Engineer. • Workers should abide by the health and safety instructions and guidelines set by the government of Jordan as well as the guidelines issued by KfW to reduce the risk of COVID-19 outbreak. 	
10.	Occupational Health and Safety	<ul style="list-style-type: none"> • The Contractor has to ensure that all workers have access to protective measures, particularly (as a minimum): • The Contractor shall comply with the KfW Specifications for Project Area Environmental, Social, Health and Safety Management (ESHS). • The Contractor shall nominate a qualified H&S Engineer dedicated for the site. The H&S Engineer and the Contractor shall be responsible for ensuring of that a safety plan is prepared adhered to and shall co-ordinate with the sub-contractors and or other persons required to be working on or near the site for proper implementation during the execution of the works. • Workers shall be briefed regularly on occupational health and safety regulations. • The contractor has to provide side security especially when working at height. • A grievance mechanism for workers (contractor and sub-contractor) has to be in place. 	Contractor

No.	Aspect	Mitigation measures	Responsibility
		<ul style="list-style-type: none"> • Workers exposure shall be reduced with the use of and proper care of protective clothing and equipment (PPE). • The Contractor shall provide sufficient drinking water for worker and, locations where protection against sun would be provided during breaks. • Traffic control measures, including road signs and flag persons to warn of dangerous conditions shall be implemented. The Construction vehicles shall comply with speed limits. Speed limits for heavy vehicles within construction site shall be restricted to 20 km/hr. • The Contractor shall install fences, barriers, dangerous warning/prohibition signs around the construction area in order to protect the workers. • Ground movement shall be controlled and collapse prevented by systematically shoring, sloping, benching, etc. • The Contractor shall develop and implement appropriate fire precautionary measures as per the H&S Plan in accordance with the requirements of the appropriate Local Standards for Construction. • Contractor must comply with Guide 12 issued by the Ministry of Labour to reduce the risks of COVID-19 spread amongst workers; contractor must also ensure that KfW Info-Sheet on COVID-19 is taken into consideration during the construction phase. 	
11.	Traffic Control	<ul style="list-style-type: none"> • The Contractor shall submit a Traffic Management Plan (TMP) taking into consideration current traffic profiles in addition to suitable locations for bypasses, bus stops, drop-offs etc. • The Contractor shall comply with all the applicable laws with regard to road safety and transport. The Contractor shall instruct its drivers and equipment operators that vehicles will be expected to comply with all road ordinances, such as speed limits, roadworthiness, load securing and covering. • The Contractor's vehicles shall be permitted only within the designated work sites or on existing roads, as would be required to complete their specific tasks. Vehicles are not permitted on re-vegetated areas, and site traffic shall be limited to prevent unnecessary damage to the natural environment. • Continuous unobstructed, safe and adequate pedestrian and vehicular access shall be provided to fire hydrants, commercial and industrial establishments, public entities such as mosques, schools, parking lots, service location, police stations and hospitals. • If relevant, the Contractor shall arrange with property owners to establish and maintain temporary access roads to various parts of his site as required to complete the works at his own cost. • Such roads shall be available for the use of all others performing work or furnishing services in connection with the contract. • Existing public access roads used by the Contractor in connection with the execution of the contract shall also be maintained by the Contractor. 	Contractor

No.	Aspect	Mitigation measures	Responsibility
12.	Labour Force Management	<ul style="list-style-type: none"> • The Contractor shall ensure continuous compliance to all Labour obligations outlined in the local legislative framework, IFC Performance Standards, and ILO stipulations. • The Contractor shall ensure the implementation of a just Human Resource Policy and related procedures and communicated clearly to its workforce. • The Contractor shall comply and respect workers' rights as per local legislations and other relevant international requirements to cover topics such as wages, compensation, benefits, workers' organization, clear grievance mechanisms, retrenchment, accommodation, etc. • The Contractor shall commit to non-discrimination employment procedures with equal opportunities, and prohibit forced and child labour as well as protecting workers including vulnerable groups such as women and migrant workers. 	Contractor
Biological Environment			
13.	Flora	<ul style="list-style-type: none"> • If relevant, clearing of vegetation shall be confined to that necessary for the establishment of required infrastructure and lay down areas. • If relevant, trees, shrubs, or other flora on pathways and/or access roads are to be protected by appropriate means. • If relevant, removed vegetation shall be replaced at Contractor's own expense by re-planting indigenous species. 	Contractor

Table 7-1: Environmental and social mitigation measures during construction phase

No.	Aspect	Mitigation measures	Responsibility
Physical Environment			
1	Land and Soil	<ul style="list-style-type: none"> The operator shall ensure proper waste management practices are implemented to avoid any leakages within the premises of the school. 	Operator
2	Water Resources	<ul style="list-style-type: none"> The operator shall ensure sound connection to existing water distribution networks. The operator shall ensure sustainable use of water resources within the schools' operation and avoid any over consumption. 	Operator
3	Waste Generation and Disposal	<ul style="list-style-type: none"> A dedicated waste management plan shall be developed and implemented based on a minimization approach and high-quality housekeeping practices. The operator shall segregate storage for different types of wastes, such as hazardous, non-hazardous recyclable construction material, plastic, paper, etc. to facilitate proper disposal as per waste management plan. The Operator shall establish regular intervals for waste collection and disposal as per waste management plan. The sanitary and organic wastes shall be collected and disposed daily. 	Operator
4	Visual and Aesthetic	<ul style="list-style-type: none"> The Operator shall ensure general cleanliness and good housekeeping practice at school premises at all times. Littering in the project area and surrounding areas shall be prohibited. Operator shall maintain a housekeeping plan to prevent littering in the school and surrounding areas. The operator shall progressively maintain the school's premises to avoid any adverse impacts to the visual and aesthetics of the area. 	Operator
Socio-Economic Environment			
5	Socio-economic and Social Disturbance	<ul style="list-style-type: none"> The operator shall maintain open communications with the local municipality and concerned residents (erect notification boards at construction site providing information about the project and contact numbers). A grievance mechanism for concerned community and individuals has to be in place. Operator must take into account all health and safety precautions and measures issued by KfW as well as the Government of Jordan during the operation phase to reduce the risks of COVID-19 outbreak 	Operator
6	Community Health and Safety	<ul style="list-style-type: none"> School buses shall comply with speed limits. Speed limits for heavy vehicles within construction site shall be restricted to 20 km/hr. Ensure security measures are in sound conditions around the school to ensure protection of the school children in addition to the local community. 	Operator

No.	Aspect	Mitigation measures	Responsibility
		<ul style="list-style-type: none"> Ensure sound traffic control measures are well identified and clearly presented within the vicinity of the school. 	
7	Occupational Health and Safety	<ul style="list-style-type: none"> Ensure that all employees have access to protective measures, particularly (as a minimum): Workers exposure shall be reduced with the use of and proper care of protective clothing and equipment (PPE). Ensure Occupational Health and Safety (OHS) Awareness training is provided for staff, at least the head staff of the school. 	Operator
8	Traffic Control	<ul style="list-style-type: none"> The operator shall comply with all the applicable laws with regard to road safety and transport, such as speed limits, roadworthiness, and load securing and covering. The operator shall monitor a sufficient road width allowing safe conditions for bus drop off of children and parents. As far as appropriate, a safety system allowing the safe access of the bus drop off has to be considered. During school hours a guidance team has to provide support to children accessing the bus drop off safely. Ensure proper roads for pedestrians and easy access to the School buildings. Discuss impact of traffic increase on unpaved yet roads during school hours, refer also to table 7-2 for mitigation measures and possible additional investment involved. 	Operator
Biological Environment			
9	Flora	<ul style="list-style-type: none"> Implement proper means methods of waste management and disposal to limit the impact of local flora and fauna. If relevant, trees, shrubs, or other flora on pathways and/or access roads are to be protected by appropriate means. If relevant, removed vegetation shall be replaced at Contractor's own expense by re-planting indigenous species. 	Operator

Table 7-2: Environmental and social mitigation measures during operation phase

7.3. Environmental and Social Monitoring during Construction & Operation

The previous section outlines mitigation measures to ensure that adverse effects during project implementation are avoided. In order to ensure that this mitigation measures are effective and properly implemented the following monitoring plan shall be implemented and maintained. This chapter discusses the environmental and social performance monitoring that shall be undertaken to evaluate efficiency of mitigation measures and provide a feedback about the actual environmental and social impacts from construction activities.

Monitoring also will ensure compliance with environmental and social standards and will facilitate any required changes and improvements. The monitoring requirements are discussed for each environmental and social aspect during construction and operation phases in Table 7-3 and Table 7-4 respectively.

Aspect	Monitoring	Frequency	Sampling locations	Method	Responsibility	Reporting	Oversight	Performance Indicator
Physical Environment								
Air and Dust	Emissions from vehicles and equipment Dust generated from construction activities, construction vehicle movement, stockpiles, storage of construction materials, etc.	Daily	At construction site (emission source)	Source emission monitoring Visual monitoring	Contractor	Contractor shall prepare and submit monthly report to Engineer who will in turn communicate to the Employer	Engineer	<ul style="list-style-type: none"> • Compliance with Jordanian ambient air quality Standards JS 1140/2006. • Complete records of monitoring activities. • Regular vehicle maintenance records. • No visible dust plumes originating from construction sites. • No irregular exhaust (heavy black or white smoke) from equipment and vehicles.
Noise and Vibration	Noise monitoring at 1.5 m above ground. A third person or entity can perform noise monitoring in the case of non-availability of noise meter with the contractor.	Noise monitoring at designated spots	At construction site (emission source) and on demand at critical locations	Noise monitoring using portable noise meters	Contractor	Contractor shall prepare and submit weekly report to Engineer who will in turn communicate to the Employer	Engineer	<ul style="list-style-type: none"> • Compliance with Noise Instructions (2003) • Complete records of monitoring activities.
Land and Soil	Visual inspection of disturbed area in and around construction site for erosion.	Daily	At construction site At construction site in waste storage area, chemical	Visual monitoring	Contractor	Immediate reporting to Engineer in case of accidental spillage. All unplanned	Engineer	<ul style="list-style-type: none"> • Up-to-date and complete records as required by spill prevention and response procedures. • Training records of personnel on spill

Aspect	Monitoring	Frequency	Sampling locations	Method	Responsibility	Reporting	Oversight	Performance Indicator
	<p>Visual inspection of waste storage area, chemical storage area and fuel storage area for spills and leaks.</p> <p>Visual inspection of vehicles, machinery and equipment for leaks of oils, grease, etc.</p>		<p>storage area and fuel storage area</p> <p>At construction site and vehicle parking area</p>			incidents/accidents must be recorded as part of CESMP implementation.		prevention and response procedures.
Water Resources	Visual inspection of any erosion from construction area and transport of sediments and contaminants (e.g. oil, grease).	On demand, run-off after heavy rainfall events	Construction site (trenches, sloped areas)	Visual monitoring	Contractor	Contractor shall prepare and submit monthly report to Engineer who will in turn communicate it to the Employer	Engineer	<ul style="list-style-type: none"> Runoff from constructions site should be clear of heavy particulates, oils/chemicals, or trash. Up-to-date and complete records as required by spill prevention and response procedures.
	Check all wastewater (that might be collected from trenches and manholes during construction) are diverted to drain pit and disposed of appropriately.	Daily	Construction site (trenches, sloped areas)	Visual monitoring	Contractor	Contractor shall prepare and submit monthly report to Engineer who will in turn communicate to the Employer	Engineer	<ul style="list-style-type: none"> Number of spills or incidents as recorded during on-site inspections. Complete records of wastewater disposals (volume to be transferred to next appropriate site) Training records of personnel trained in

Aspect	Monitoring	Frequency	Sampling locations	Method	Responsibility	Reporting	Oversight	Performance Indicator
								emergency response/spill prevention and response procedures.
Waste Generation and Disposal	<p>Site clean and proper storage and handling of (hazardous) waste and sewage.</p> <p>Segregated waste disposal or storage areas are clearly marked.</p> <p>Toilet facilities are readily available near the construction site for all workers.</p>	Daily	At construction sites	Visual monitoring	Contractor	Contractor shall prepare and submit monthly report to Engineer who will in turn communicate to the Employer	Engineer	<ul style="list-style-type: none"> • Compliance with waste management plan. • Current and complete records of regular waste collection and disposal. • Records of workers attending follow-up health and safety training on monthly basis. • Compliance with applicable regulations including: <ul style="list-style-type: none"> • Regulation of Solid Waste Management No. 27 of the year 2005 • Regulation of Harmful and Hazardous Waste Management, Transfer and Handling No. 24, 2005 • Instructions for Recycling and Handling of

Aspect	Monitoring	Frequency	Sampling locations	Method	Responsibility	Reporting	Oversight	Performance Indicator
								Consumed Oils of the year 2003
Visual and Aesthetics	<ul style="list-style-type: none"> Visual inspection of general cleanness at site, rehabilitation of damaged roads and waste management 	Daily	At construction sites	Visual Monitoring	Contractor	Contractor shall prepare and submit monthly report to Engineer who will in turn communicate to the Employer	Engineer	<ul style="list-style-type: none"> Construction areas are properly restored to original conditions. No construction materials or wastes are present after construction is completed.
Socio-economic Environment								
Socio-economic & Social Disturbance	<p>Monitor health, safety and security requirements are considered and respected</p> <p>If relevant, olive trees are safely replanted</p> <p>If relevant, loss of olive trees compensated</p>	<p>Monthly</p> <p>On demand</p> <p>On demand</p>	At construction site and surrounding community	<p>Visual monitoring, meetings with community leaders</p> <p>Inspection</p> <p>Inspection</p>	Contractor Community leader	Contractor shall prepare and submit monthly report to Engineer who will in turn communicate to the Employer	Engineer	<ul style="list-style-type: none"> No identified non compliances of health and safety procedures. Review of grievance register Photo documentation Compensation note
Occupational Health and Safety	Visual inspection of compliance with health and safety procedures	Daily	At construction sites	Visual	Contractor	Contractor shall prepare and submit monthly report to Engineer who will in turn	Engineer	<ul style="list-style-type: none"> No identified non compliances of health and safety procedures. Regular training records of personnel

Aspect	Monitoring	Frequency	Sampling locations	Method	Responsibility	Reporting	Oversight	Performance Indicator
	Monitor working conditions: <ul style="list-style-type: none"> • H&S training provided • Use of personal protective equipment for workers • Accessibility of workers to grievance mechanism 	Random site inspection Monthly		Check training records Visual Grievance mechanism in place and grievances recorded	Contractor Employer Contractor Contractor Employer	communicate to the Employer.	Engineer Engineer Engineer	on health & safety procedures on site. <ul style="list-style-type: none"> • Injuries or accidents to workers/personnel on site are reported and investigated promptly and in compliance with the health and safety procedures. • H&S training provided • PPE used on site by workers • Review of grievance register
	Regular controls and testing by the competent health authorities	Random Inspections	At Construction sites	Health inspections and test	Ministry of Health	Immediate reporting to health authorities in case of any symptoms. All medical tests must be recorded. Contractor shall keep track of all workers on site at any day.	Engineer and Ministry of Health	<ul style="list-style-type: none"> • No positive COVID-19 cases
Community Health and Safety	Monitor health, safety and security requirements	Monthly	At surrounding community	On-site visits and communication; interviews	Contractor Community leader	Contractor shall prepare and submit monthly report to Engineer	Engineer	<ul style="list-style-type: none"> • No identified non compliances of health and safety procedures.

Aspect	Monitoring	Frequency	Sampling locations	Method	Responsibility	Reporting	Oversight	Performance Indicator
	are considered and respected			with, community leaders		who will in turn communicate to the Employer		<ul style="list-style-type: none"> Regular training records of personnel on health & safety procedures on site. Review of grievance register
	Ad hoc intervention in case any of the workers show symptoms of a COVID-19 infection	When necessary	At construction sites and in surrounding communities	As per government's recommendations	Contractor Employer	Immediate reporting to health authorities in case of any symptoms. All medical tests must be recorded. Contractor shall keep track of all workers on site at any day.	Engineer and Ministry of Health	<ul style="list-style-type: none"> Minimal rate of infection with positive COVID-19
Traffic Control	<p>Monitor road condition and signage and traffic calming needs.</p> <p>Monitoring access of residents to own properties and public entities.</p>	Daily	At construction site	Visual spot check and inspection	Contractor	Contractor shall prepare and submit monthly report to Engineer who will in turn communicate to the Employer.	Engineer	<ul style="list-style-type: none"> Pedestrians and property owners are able to access public entities, business and private homes as expected. All signage maintained and available at all times. All accidents between construction vehicles and private vehicles are reported and investigated promptly and in compliance

Aspect	Monitoring	Frequency	Sampling locations	Method	Responsibility	Reporting	Oversight	Performance Indicator
								with health and safety procedures. • Accidents and incidents are reported and investigated promptly.
Labour Force Management	Inspect the completeness and comprehensive HR Policy	Quarterly	At construction site	Inspection	Contractor	Contractor shall prepare and submit monthly report to Engineer who will in turn communicate to the Employer.	Engineer	• Sound employment processes • Proper implementation of Grievance mechanisms • Implementation of a fair salary scale • No discrimination, forced, or child labour
Biological Environment								
Flora	• Trees, shrubs on pathways and/or access roads are protected	Random site inspection	At construction sites	Inspection	Contractor	Contractor shall prepare and submit monthly report to Engineer who will in turn communicate to the Employer.	Engineer	• Revegetation completed • Review of grievance register

Table 7-3: Environmental and social monitoring during construction

Aspect	Monitoring	Frequency	Sampling locations	Method	Responsibility	Reporting	Oversight	Performance Indicator
Physical Environment								
Land and Soil	Visual inspection of waste storage area, chemical storage area and fuel storage area for spills and leaks. Visual inspection of vehicles, machinery and equipment for leaks of oils, grease, etc.	Daily	At school premises in waste storage area, chemical storage area and fuel storage area At school premises and vehicle parking area	Visual monitoring	Operator	Immediate reporting to Employer in case of accidental spillage.	Employer	<ul style="list-style-type: none"> Up-to-date and complete records as required by spill prevention and response procedures. Training records of personnel on spill prevention and response procedures.
Water Resources	Ensure sound connection to distribution network by coordinating with the responsible water utility.	Once, prior to operation activities	At school premises	Official communication	Operator	Reporting to Employer.	Employer	<ul style="list-style-type: none"> Up-to-date and complete records of water supply and water bills.
Waste Generation and Disposal	Inspection of implementation of waste management plan and housekeeping practices	Daily	At school premises	Visual monitoring	Operator	Reporting to Employer.	Employer	<ul style="list-style-type: none"> Up-to-date and complete records as required by spill prevention and response procedures. Training records of personnel on spill prevention and response procedures.
Socio-economic Environment								
Socio-economic and Social Disturbance	Inspection of sound implementation	Daily	At school premises	Official communication	Operator	Reporting to Employer.	Employer	<ul style="list-style-type: none"> Up-to-date and complete records of responses to received grievances

Aspect	Monitoring	Frequency	Sampling locations	Method	Responsibility	Reporting	Oversight	Performance Indicator
	of grievance mechanism							
Community Health and Safety	Inspection of effective security measures within school premises	Daily	At school premises	Official communication & Visual monitoring	Operator	Reporting to Employer.	Employer	<ul style="list-style-type: none"> Up-to-date and complete records of security monitoring and responses.
	Ad hoc intervention in case any of the students/staff show symptoms of a COVID-19 infection	When necessary	At school premises and in surrounding communities	As per government's recommendations	Operator	Immediate reporting to health authorities in case of any symptoms. All medical tests must be recorded. Operator shall keep track of all workers at the school in any day.	Ministry of Health	<ul style="list-style-type: none"> Minimal rate of infection with positive COVID-19
Occupational Health and Safety	Inspection of Personal Protective Equipment (PPE)	Daily	At school premises	Official communication & Visual monitoring	Operator	Reporting to Employer.	Employer	<ul style="list-style-type: none"> Up-to-date and complete records of PPEs and records of any incidences and appropriate responses.
	Regular controls and testing by the competent health authorities	Random Inspections	At school premises	Health inspections and test	Ministry of Health	Immediate reporting to health authorities in case of any symptoms. All medical tests must be recorded.	Ministry of Health	<ul style="list-style-type: none"> No positive COVID-19 cases

Aspect	Monitoring	Frequency	Sampling locations	Method	Responsibility	Reporting	Oversight	Performance Indicator
Traffic Control	Inspection of traffic conditions, safe drop off zones	Daily	At school premises	Official communication & Visual monitoring	Operator	Reporting to Employer.	Employer	<ul style="list-style-type: none"> Up-to-date and complete records of traffic control issues and records of any incidences and appropriate responses.

Table 7-4: Environmental and social monitoring during operation

8. STAKEHOLDER ENGAGEMENT PLAN

The Consultant has prepared an initial Stakeholder Engagement Plan (SEP) providing information on the different stakeholders involved in the project. The central purpose of the SEP is allowing the public to participate in and follow up all activities under the project.

Reference is made to Chapter 4.2 preliminary documenting the concerned stakeholders.

Meaningful stakeholder engagement during the construction phase of the project ensures that the school construction can be conducted with the least disruption to local stakeholders and that all realistic expectations regarding a project's commitments and conditions are met. In turn, minimising disruption and meeting expectations are likely to ensure stakeholder factors do not affect project execution through delay and/or interference.

The engagement processes to be followed during construction should be planned and documented during the planning and/or design stage, leading to a more certain, less resource-intensive process for all involved stakeholders. Stakeholder engagement is primarily a day-to-day activity of the construction contractor(s) assisted by the Engineer and the Employer.

On the other hand, following the IEE site visits in April 2019 concerned residents in the Project area are aware that the project implementation provides significant benefits and that corresponding negative impacts are short-term and mitigatable.

Upon award, the Contractor shall replace this proposed SEP Framework with his own comprehensive SEP, that should include immediate responses for specific issues.

8.1. Grievance Mechanism for the Concerned Public

In general, the concerned public is mainly positive to the investment as it will lead to continuously improved educational services both with view to the number of available class rooms, but also the quality of the equipment. Nevertheless, in case of complaints or concerns a clear mechanism should be in place in order to address this grievance properly.

The stakeholder grievance structure is mainly an administrative matter, providing a frame for handling of grievances. The mechanism to be implemented is the construction contractor's public face, hence it is essential that company staff sees the grievance mechanism as a service they provide to the concerned public.

Considering that most grievances are raised on short term basis it is therefore essential that clear communication lines to the contractors grievance mechanism exist and that these are communicated to the general public.

In this context a grievance procedure specific to the project (here the individual construction contracts) will be developed with the following aims:

- To build and maintain trust with all stakeholders,
- To prevent adverse consequences of failure to adequately address grievances; and
- To identify and manage stakeholder concerns and thus support effective risk management.

Grievance Procedure

The Grievance Procedure will be free, open and accessible to all and comments and grievances will be addressed in a fair and transparent manner. Information about the procedures, who to contact and how, will be made available.

In particular all workers will be informed of the grievance process and new workers will be informed when they join the project. The grievance procedure comprises the following steps:

1. **Identification of grievance:** Stakeholders shall be able to use the following methods to submit a grievance:
 - Oral by directly contacting the Contractor's Liaison Officer, by phone or SMS;

- By filling the grievance form; and
- In writing via the grievance box located at the Contractor's and/or the Engineer's site office.

It is essential that the complaint structure is designed for the customer's convenience, thus should not require difficult administrative procedures. In general, the grievance registration should entail:

- How the complaint was raised (phone, in person, via the grievance form, in writing etc.)?
 - Who issues the complaint?
 - What the complaint is about?
 - Date and location?
 - Who received the complaint at the company?
2. **Grievance is formally acknowledged** through a personal meeting, phone call, or letter as appropriate, within 2 working days of submission. If the grievance is not well understood or if additional information is required, clarification should be sought from the complainant during this step.
3. **Handling of the complaint:** The Contractor's Liaison Manager delegates the complaint internally in writing to the relevant staff/personnel for development of an appropriate response. If required, the grievance may be send for consideration of the senior management. The Contractor's Liaison Manager will address the following issues:
- How the complaint should be prioritised?
 - Who in the company and external (e.g. public, Engineer, Employer) must be informed?
 - Who in the company is responsible for dealing with the complaint?
 - Minimum requirements in communication with the complainer (call, visit, follow-up) of the responsible officer at the company.
 - Timeframes and quick response procedures.
 - Forms (computerised) to be filled in by company staff.

Beyond the information channels described before, the Contractor shall provide information on designated contact points and staff/site information boards along with corresponding information on further progress on works.

4. **A response** is developed by the delegated team and Contractor's Liaison Manager with input from the Senior Management (if required) and others, as necessary.

The response to a grievance will be provided 1 week days after receipt of the grievance.

Should the need arise; the Contractor will consider the establishment of a conflict resolution committee (involvement of contractor, Engineer, Employer, local authorities, complainant etc.) for the management of complex grievance issues.

5. **Required actions are implemented** to deal with the issue, and completion of these is recorded on the grievance documentation.

The response of the complainant is recorded to help assess whether the grievance is closed or whether further action is needed. The Contractor's Liaison Manager should use appropriate communication channels, most likely telephone or face to face meeting, to confirm whether the complainant has understood and is satisfied with the response. The complainants' response should be recorded in the grievance documentation.

If actions taken on a grievance are not successful, a stakeholder may turn to court in accordance with the existing legislation of Jordan.

6. **Further actions** require the documentation of all individual complaints in the regular monthly reporting to the Engineer and Employer. Corresponding information records shall be also provided by the Employer to the international financing agency (here KfW) at quarterly basis.

An exemplary grievance mechanism procedure is illustrated in Figure 8-1.

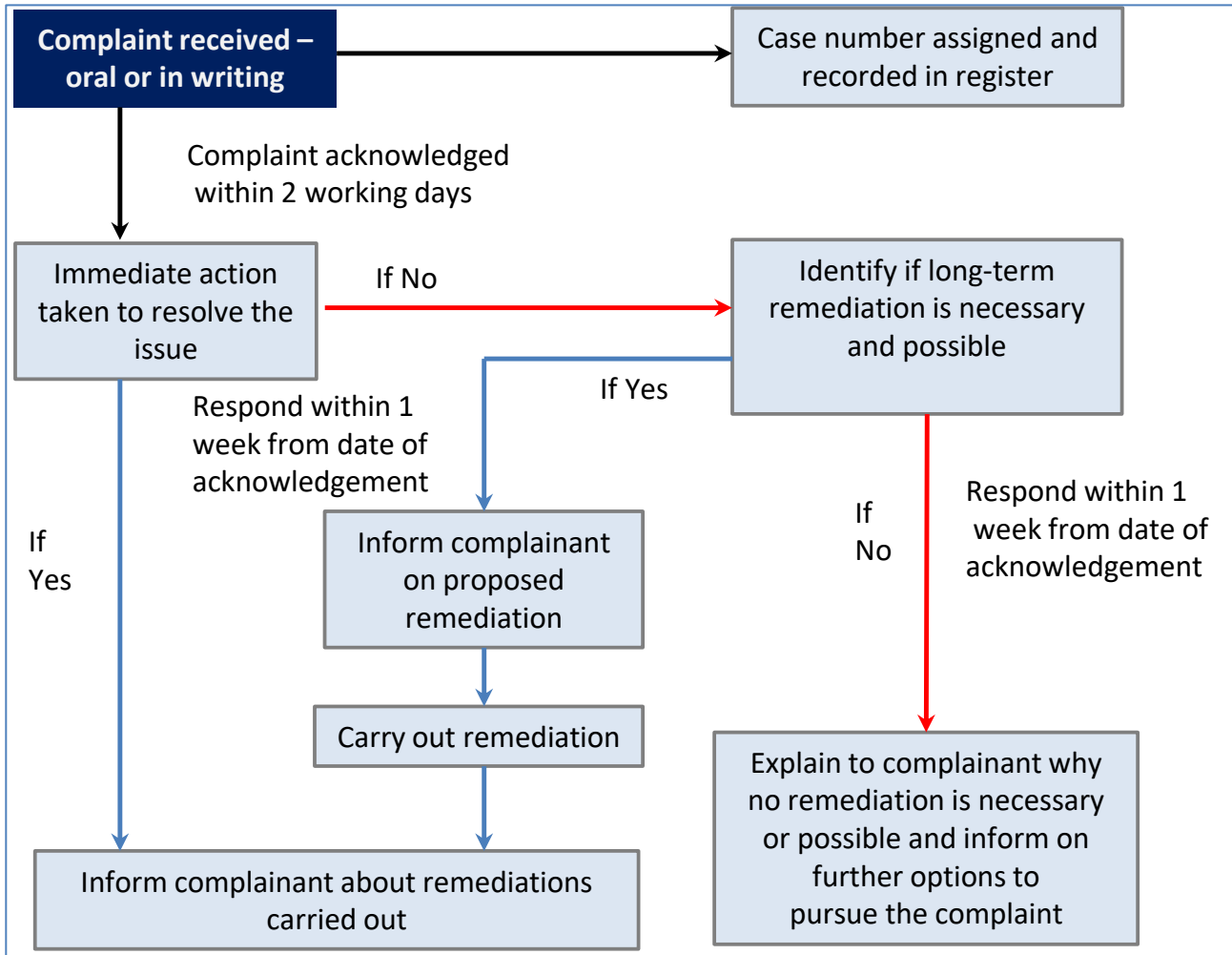

Figure 8-1: Proposed Grievance Mechanism Procedure

8.2. Grievance Mechanism for Workers

It is important that workers are treated fairly and receive prompt responses to problems and concerns. Otherwise, grievances may take the form of collective disputes when they are not resolved. Also they will then lower the morale and efficiency of the employees. Unattended grievances result in frustration, dissatisfaction, low productivity, and lack of interest in work.

Grievance may result from the following factors:

- Improper working conditions such as strict production standards, unsafe workplace, bad relation with managers, etc.,
- Irrational management policies such as overtime, transfers, demotions, inappropriate salary structure, etc., and/or
- Violation of organizational rules and practices.

Grievance procedures provide a clear and transparent framework to deal with difficulties that may arise as part of their working relationship from an worker's perspective. It is important that workers have a course of action available, should they have a complaint. Procedures are necessary to ensure that everybody is treated in the same way in similar circumstances and to ensure issues are dealt with fairly, reasonably and in a timely manner.

There is no prescribed form for grievance mechanisms but there are guiding principles that should underpin them as introduced hereafter:

1. **Quick action:** As soon as the grievance arises, it should be identified and resolved. Training must be given to responsible staff to effectively and timely manage a grievance. This will lower the detrimental effects of grievance on the employees and their performance.
2. **Acknowledging grievance:** The managing staff must acknowledge the grievance put forward by the worker as manifestation of true and real feelings of the employees. Acknowledgement by the manager implies that the manager is eager to look into the complaint impartially and without any bias. This will create a conducive work environment with instances of grievance reduced.
3. **Gathering facts:** The managing staff should gather appropriate and sufficient facts explaining the grievance's nature. A record of such facts must be maintained so that these can be used in later stage of grievance redressal.
4. **Examining the causes of grievance:** The actual cause of grievance should be identified. Accordingly, remedial actions should be taken to prevent repetition of the grievance.
5. **Decision Making:** After identifying the causes of grievance, alternative course of actions should be thought of to manage the grievance. The effect of each course of action on the existing and future management policies and procedure should be analysed and accordingly decision should be taken by the managing staff.
6. **Execution and review:** The managing staff should execute the decision quickly, ignoring the fact, that it may or may not hurt the employees concerned. After implementing the decision, a follow-up must be there to ensure that the grievance has been resolved completely and adequately

In order to guarantee a quick and effective way of providing a grievance the construction contractors should install secret post boxes at selected places allowing workers the anonymous provision of their cases.

8.3. Monitoring of Stakeholder Engagement Plan

Up to the present, there is no structured approach at the Employer's site to the SEP. Therefore, in order to avoid lack of ownership the SEP monitoring need to be addressed and harmonised among Contractor, Engineer and Employer.

Monitoring is important for the SEP and can be done in different ways. The Consultant proposes a monitoring that is on a continuous basis. The SEP must be a vivid instrument at the hands of the Employer and relevant for the objective to achieve, hence it must be strategic, but also flexible.

It is therefore proposed that the responsible Engineer's staff assisted by the Contractor's staff reports at internal meetings with the Employer's focal point on the progress of SEP implementation. Meeting formats should be developed addressing the following issues:

- To whom have we communicated with (and about what)?
- Did we get the results we expected with the communication?
- If No – why not and what can we change? (Consequently, adaptation of the SEP will be required).
- If Yes – how can we show that we achieved the results (gather 'evidence' of results – indicators are, inter alia, such evidence).

The half-yearly progress report should analyse (in general):

- How the project has developed (activities and budget)?
- What has the project achieved (results – short and medium term)?
- How the context of the project has developed? (Here an analysis of stakeholders is important and the progress/setbacks related to the SEP).

For the half-yearly progress report, it would be advantageous to have a workshop with a group of representative staff of the Contractor(s), Engineer(s) and selected stakeholders (residents and business representatives) in order to develop lessons learnt and support actions considering the strategic SEP purpose.

Annex 1: Official Letter of MoEnv regarding EIA procedures



٢٥٣٤٠ ٧ / ١٠٠ / ٣

الرقم ٢٠١٩٠٠٦٠١٦

التاريخ

الموافق

شركة دorsch

Dorsch International Consultants GmbH

**Subject: School Construction Programme
Official letter from Ministry of Environment**

Dear Madam / Sir,

With reference to Ministry of Environment official letter No. 4/7/4680 dated 29/05/2019
Enclosed herewithin.

Kindly note that the above mentioned official letter from Ministry of Environment states that: "this project does not require any Environmental Impact Assessment with reference to by law No 37 for the year 2005".

Yours sincerely

Minister of Public Works and Housing

Eng. Falah Abdullah Al-Omsh

الأمين العام
المهندس عمار غرايبة

CC: H.E. Minister Public Works & Housing.
CC: Minister of Planning & International Cooperation.
CC: H.E. Minister of Education and Minister of Higher Education and Scientific Research
CC: H.E. Secretary General of Ministry of Public Works and Housing
CC: Dorsch International Consultants GmbH, Munchen, Germany with Dar Al Ofran,
Jordan & AHT Group AG, Essen, Germany.
CC: KFW Office Amman/phone: 5854378/ Fax: 5854573
CC: Director of Technical Affairs of Building Studies.
CC: Director of Building Studies.
CC: Eng Rula AlTamimi.

Attachment: Ministry of Environment official letter No. 4/7/4680 dated 29/05/2019

٣. وطن التوقيع

المملكة الأردنية الهاشمية

عناقه: ٢٥٨-٣٨٠٣-٩٦٢ فاكس: ٩٦٢ ٦ ٥٨٦٥٩٠ ص.ب: ١٢٢٠ عمان ١١١١٨٨ الأردن. البريد الإلكتروني: mpwh@mpwh.gov.jo

Annex 2: Initial Environmental Examination (IEE) Protocols

Date: 3rd April, 2019



29th April 2019 (Dorsch E&S team): C. Brüggemann, Dr. D. Matzke, S. Al Hmoud





Site: Howwara School in Qasabet Irbid





Community Representatives: Sahar Irshaidat (Directorate of Education)



Contact Details: +962 79 651 9878

PS 1: Assessment and Management of Environmental and Social Risks and Impacts	Yes	No
Plot of land of a uniform shape?	✘	
Steep slope on site?		✘
If there is a slope, is it towards the street / a natural Wadi? (for easy drainage)		✘
Site higher than surrounding streets?		✘
Nearby disposal or waste collection area?		✘
Heavy traffic in the area?		✘
Access and dispersal roads nearby?	✘	
On a major street and / or intersection?		✘
Dusty / lower air quality?		✘
Likelihood of natural disasters to occur?		✘
Access to medical / communal / religious services? <i>The next mosque, Al Iman Mosque, is some 750 m away from the proposed site. Medical and communal service facilities are located in the town.</i>	✘	
Presence of buildings that are not structurally fit as educational buildings?		✘
Proximity to natural water resources (surface water, groundwater)?		✘
Proximity of socio-economic activities (i.e. shops, salons, day-care centres... etc.)		✘





PS 2: Labour & Working Conditions	Yes	No
Is the area a residential area? <i>Yes, but sparsely populated.</i>		
Is the area an industrial area?		
Is the site on agricultural land? <i>One plot cultivated with wheat, the other plot with olive trees. But, land ownership is with MoE.</i>		



PS 3: Resource Efficiency & Pollution Prevention	Yes	No
Does the site show indications of pollution?		
Close to high decibel noise sources?		
Are there any solid waste accumulation, chemical residuals etc.?		
Are there other construction or industrial activities in the surrounding area?		

PS 4: Community Health, Safety, & Security	Yes	No
Does the site have a potential impact on the community's health, safety, & security of the surrounding community? <i>During construction of the proposed school site nearby residents will be affected by regular construction related impacts such as noise and dust. Effective mitigation has to be planned.</i>		
Have access to medical services? <i>In the town.</i>		
Nearby water utilities available?		
Electricity services available?		
And ethical conflicts due to presence of refugees?		

PS 5: Land Acquisition & Involuntary Resettlement	Yes	No
Is the site occupied?		
Are there Bedouins or tribal nomads on site?		

Do the Bedouins or tribal nomads settle in the area depending on the season?		
--	--	---

PS 6: Biodiversity Conservation and Sustainable Management of Living Natural Resources	Yes	No
Is the site part of a protected area?		
Is a lot of natural vegetation present? <i>Not relevant</i>		
Would terrestrial species be potentially affected? <i>Not relevant</i>		
Would aquatic species be potentially affected? <i>Not relevant</i>		

PS 7: Indigenous People	Yes	No
Are any indigenous people living on the site?		
Are any indigenous people living nearby the site?		

PS 8: Cultural Heritage	Yes	No
Are there any archaeological remains in the area?		

Notes & Comments > site visit dated 3rd April 2019

- Basic Mixed School. In a circumference of 3km there are no schools. Land is flat and no obvious problems in it. The closest schools are (all 3 of which are in bad shape and have already been expanded more than once, and 2 of them are double shift schools):
 - Howwara Basic Girls School
 - Al Khansa School for Girls
 - Howwara Mixed Basic School
- Is there an issue with land ownership and/or unification? – The proposed site is composed of 5 plots owned by MoE
- The site is a fresh piece of land at the outskirts of a bigger conglomeration which is utilized as fertile farm land covered partly by Olive trees and wheat with an almost unnoticeable slope. The land is big enough when utilizing the wheat planted area only for the school construction. The site is located in a residential area with large areas of empty lands that yet to be developed

Conclusion: The land is first choice for the Fast Track.

Notes & Comments > site visit dated 29th April 2019

- In terms of E&S relevant factors (physical, socio-economic, biological) the visual site inspection has shown no or insignificant conflict potential.
- Even when sparsely populated, potential negative impacts to nearby residents during the construction phase of the school can be effectively mitigated.
- In case the currently wheat cultivated plot is not sufficient for the school construction parts of the neighbouring plot cultivated with olive trees can be made available. In this case the concerned olive trees have to be safely removed and re-planted on another suitable site. According to the representative of the Directorate of Education such technology is available.

Conclusion: The high potential serving a Fast Track location can be confirmed.

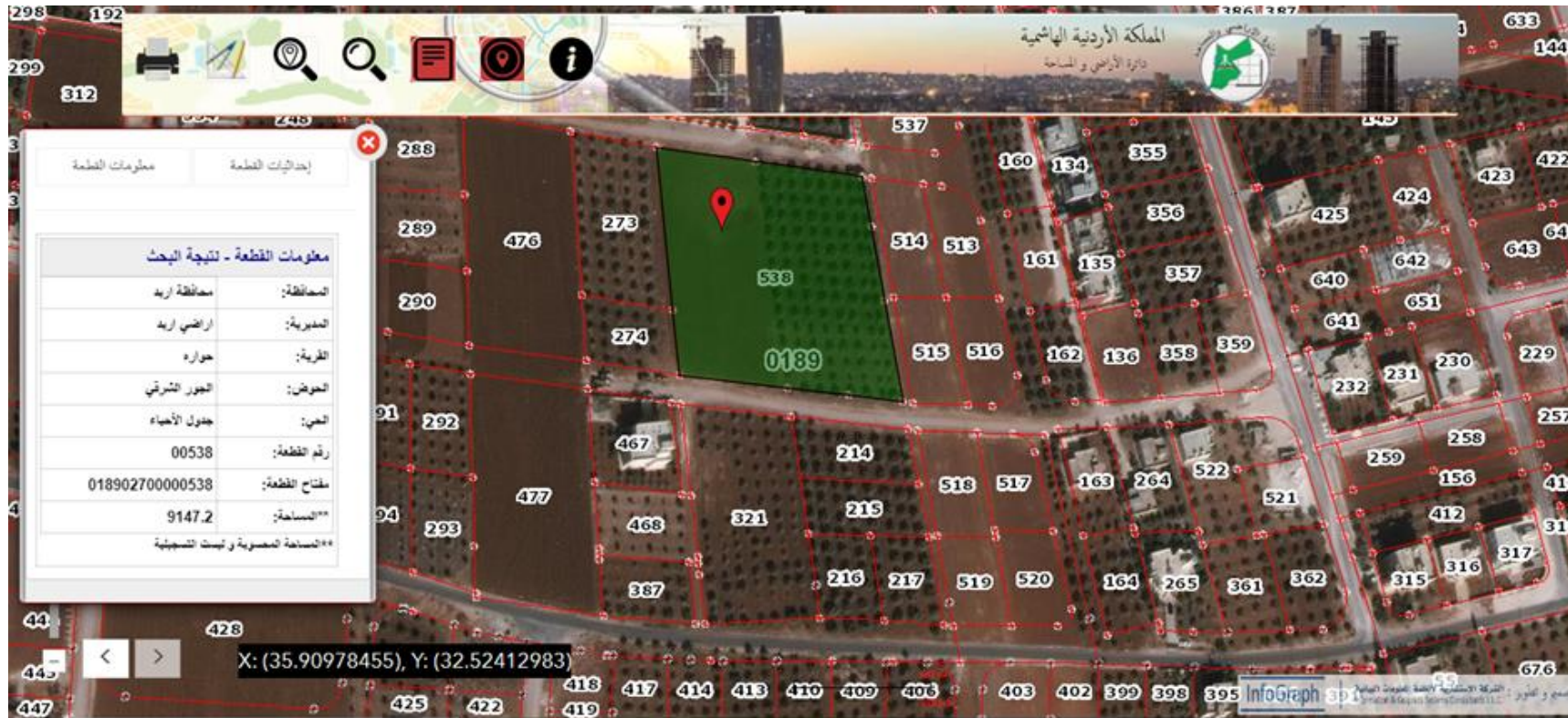

Figure: Location map Howwara site

Annex 3: No Objection of School Construction at Howwara Site



KFW

GERMAN-JORDANIAN
DEVELOPMENT COOPERATION

Consultant:



School Construction Programme (SCP)



Land Use Site Visit:
School No. 2 Howwara Basic Mixed
School



انا الموقع ادناه، أؤكد أن ممثلي وزارة التربية والتعليم والفريق الاستشاري قاموا بزيارة موقع المشروع لمناقشة أنماط استخدام الأراضي في قطعة أرض حوارة رقم 538 (المديرية: أراضي إربد ، القرية: حوارة ، حوض: الجور الشرقي).

توقيع هذا البيان لا يخضع الموقع على أي مسؤولية ، بل مجرد تأكيد على زيارة الموقع.

اسم: محمد عبد الحميد عزيز
تاريخ: 19/5/2015
التوقيع: محمد عبد الحميد عزيز

I the undersigned confirm that representatives from the Ministry of Education and from the Consulting Team have conducted a site visit to discuss the land use patterns on the Howwara land plot No. 538 (Directorate: Irbid lands, Village: Howwara, Basin: Al Jour Al Sharqi).

The signature of this document does not imply any responsibility on the signatory, rather acts as a confirmation to the site visit.

Name:

Date:

Signature:

لله يومه الآخر

نعم الحروفية اذناه مائة لقطع ذوات الارقام
(٤٤٤ ، ٤٤٠ ، ٤٤١ ، ٤٤٢ ، ٤٤٣)
هو من دعا الجور الشرفي من ارضها هو اريد

ولا مانع لدينا من استغلال لقطع المذكورة اعلاه
من قبل وزارة التربية والتعليم لاقامة ابنية
مدسية عليها ، كما باقتنا استوفينا منه
تلك لقطع ما خلا منذ عام ٢٠٠٤ .. ٢٠٠٩ .

واقبلوا الصبر
٢٠٠٩

اصحاب لقطع
على نخب غرابية
دكتور البرهان ابيات يوصف غرابية
عمره محمد غرابية
جا دو نجيب غرابية

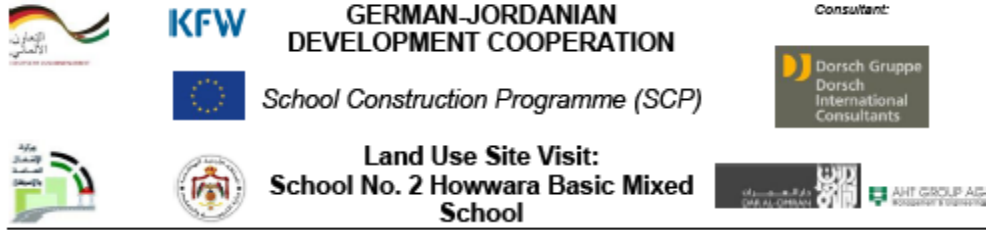

Translated letter received from previous land owners of Howwara Site

To whom it may concern,

We the undersigned, owners of the land parcels (No. 322, 210, 211, 212, 213) of Basin No. 27/ Al Jour Al Sharqi of Howwara in Irbid Governorate, have no objection to the utilization of the abovementioned lands by the Ministry of Education for the purpose of constructing school buildings; noting that we have fully received the value of the land parcels since 2004.

Respectfully,

25/08/2019

Land Owners:

Ali Najeeb Gharaibeh

Inheritors of the late Basha Yousef Gharaibeh

Hanzeh Mohammad-Ali Gharaibeh

Jad and Najeeb Gharaibeh

Annex 4: MoPWH Approval of ESIA – ESMP Report



TABLE 1

٢٠١٩ / ١

Dorsch International Consultants GmbH

٢٠١٩-٠٩-٠٩

رقم

تاريخ

واحد

Subject: Tender No. (1/2019KFW) for the preparation of studies, designs, tender documents and supervision of the execution of the (20-23) schools in various sites within the kingdom of Jordan funded by (KFW) School Construction Programme.

Approval from MoPWH on final (Draft) version the ESIA and ESMP Report for three sites

Dear Madam / Sir,

Reference to your official letter No. SCP_2019_017 dated 15th August 2019 subject: Submission final (Draft) of ESIA – ESMP Report for site No. 17 Hakama Mixed Secondary Irbid and your official letter No. SCP_2019_016 dated 15th August 2019 subject: Submission final (Draft) of ESIA and ESMP Report for site No. 1 AlNahda Secondary Mixed School Irbid and your official letter No. SCP_2019_013 dated 09th July 2019 subject: Submission final version the ESIA and ESMP Report for site No. 2 Howwara basic Mixed School and the Corresponding Comment / Response table.

MPWH gives approval on the content of the above mentioned ESIA and ESMP Reports concerning the following schools:

1. Al Nahda Secondary Mixed School Irbid (No. 1) النهضة الثانوية المختلطة
2. Howwara Basic Mixed School Irbid (No. 2) حوارة الأساسية المختلطة
3. Hakama Mixed Secondary Irbid (No. 17) حكمة الثانوية لبيدات

Yours sincerely

/ Minister of Public Works and Housing

Eng. Falah Abdullah Al-Omsh

الامين العام
للهندسة عماد شرابيد

CC: H.E. Minister Public Works & Housing.
CC: Minister of Planning & International Cooperation.
CC: H.E. Minister of Education and Minister of Higher Education and Scientific Research
CC: H.E. Secretary General of Ministry of Public Works and Housing
CC: Dorsch International Consultants GmbH, Munchen, Germany with Dar Al Omsan, Jordan & AHT Group AG, Essen, Germany.
CC: KFW Office Amman/phone: 5854378/ Fax: 5854573
CC: Director of Technical Affairs of Building Studies.
CC: Director of Building Studies.
CC: Eng Rula AlTamini
Attachment: official letters No. SCP_2019_017 dated 15th August 2019
No. SCP_2019_016 dated 15th August 2019
No. SCP_2019_013 dated 09th July 2019

المجلس الأعلى للتخطيط

مكتب تخطيط المدن، عمان، الأردن. هاتف: 5854378، فاكس: 5854573. البريد الإلكتروني: mpwh@mpwh.gov.jo

Annex 5: Public Consultation Protocol

School Site	Howwara Basic Mixed School
Venue	Quran Center / Howwara
Date	7 October 2019 // 9:00 – 12:00
Contact Person	Eng. Walid Bani Hani Head of Communication of Ministry of Education

Overall Brief

- The Consultant Team has organized a local consultation session with the support of the Directorate of Ministry of Education (MoE) for Qasabet Irbid by Eng. Walid Bani Hani on Monday 7 October 2019, to present the findings of the Environmental and Social Impact Assessment (ESIA) study as well as the results of the Environmental and Social Management Plan (ESMP) the main objectives of the School Construction Program, general details of the proposed new school.
- The audience included representatives of the local community, heads of the various decentralized units in the area as well as teachers of existing schools.
- The main outcome of the session was very positive, whereby the local community strongly supported the construction of the new school, given the current burdens Howwara faces in terms of increasing number of students that are not well accounted for in existing schools, the large number of rented schools as well as schools of double shifts that are either not well maintained up to the minimum required standards of school facilities.
- The audience expressed gratitude to the Program and for the efforts of the European Union and German Government represented by KfW Development Bank for the investment of their community, and expressed their continued support for such efforts in order to improve the overall conditions of their city.

Agenda of Local Consultation Session

9:00 – 9:05	Reading of Quran
9:05 – 9:15	Welcoming Note by Head of Howwara Municipality
9:15 – 9:25	Welcoming Note by Head of MoE – Qasabet Irbid
9:25 – 9:45	Presentation of Project / ESIA Findings and Outcomes
9:45 – 10:15	Discussion
10:15 – 10:30	Closure of Session
10:30 – 10:45	Site Visit

Topics of the Presentation

- Project Background
- Project Site Selection Process
- Elements of proposed new school including classrooms, students, impact on existing school
- Classification and identification of E&S impacts
- E&S Management and Monitoring Plan

Major Points of Discussion (Q&A Session)

Comments with Reference to the ESIA

- The attendees were supportive of the Program and the construction of additional schools in their area.
- Several representatives agreed to the importance of studying and analysing the environmental and social components relating to such a program, and highlighted the importance of contributing positively to the community.
- The attendees also stressed on the importance of assigning a suitable contractor that would abide by the Construction Environmental Management Plan (CEMP) that should address (international) best practices for community and occupational health and safety procedures, to avoid any technical issues and future adverse implications on the school building itself and affected parties.
- The attendees highlighted the importance of properly managing potential impacts of noise and dust, especially during the construction works.
- Given the location of the proposed site, the attendees had no objection from an environmental or social perspective to construct a school on such boundaries.

Additional Comments

- The attendees were grateful for the support of the EU and KfW in investing such a program, but requested to consider the opportunity of constructing additional schools in different areas given the overcrowding of existing schools and large demand of schools of various levels, as well as considering the maintenance of existing schools that experience faulty designs and construction works, that no longer provide adequate learning spaces for students and teachers alike.
- The main issue raised is that the name of the school should be Howwara Secondary School, rather than Basic, as the grade levels exceed 10th grade.

Local Consultation Session Pictures



List of Attendees

No.	Name	Position	Mobile Number
1	Sahar Rshaidat	Head of Buildings Dept. / Directorate of Qasabet Irbid	0796519878
2	Ibrahim Hamouri	Chairman of educational development council / Manager of educational council	0791602752
3	Abd Alrahman Tanash	Retired supervisor	0796569853
4	Bakeer Al Talaa'	Retired landlord	0799057748
5	Fawzi Abd Alrahman Ababneh	Retired	0799941944
6	Mohammed Abd Al Kareem Ababneh	Member of Governorate Council	0788773204
7	Ibraheem Al Tanash	Member of Governorate Council	0772121524
8	Rasheed Karasneh	Citizen	-
9	Abeer Mryan	Principal of Howwara Secondary School for Girls	0798439514
10	Elham Masaadeh	Principal of Al Khansaa Basic Mixed School	0772084334
11	Ahmad Al Shatnawi	Principal of Howwara Basic School for Boys	0772327807
12	Hussein Al Shatnawi	Howwara Youth Club	0777426642
13	Bashar Ahmad Salem Gharaibeh	Retired	0795114850
14	Monther Hussein	Assistant Teacher	0785771766
15	Mahmoud Mefleh Al Shatnawi	Retired teacher	0789403614
16	Qassem Mahmoud Ahmed Shatnawi	Retired teacher	0786647904
17	Ahmed Mahmoud Shatnawi	Retired	0777390114
18	Turki Mohammed Shatnawi	Retired	0772065252
19	Waheed Ababneh	Howwara Educational Development Council	0772009542
20	Muneer Gharaibeh	-	0795448463
21	Abeer Ayed Al Shatnawi	-	0795970340
22	Tayseer Hussein Al Shatnawi	-	0798443649
23	Rateb Ali Shatnawi	-	0785546736
24	Fouad Suleiman Shatnawi	-	0772409254
25	Eissa Nasser Karasneh	-	0787992627
26	Hani Shatnawi	-	0785204280
27	Nabil Shatnawi	Head of Howwara Local Committee	0799383151
28	Hilal Al Sharou'	Head of Network Development Committee of Howwara	0795298706